

276053

REPLACEMENT PARTS

ITEM	PART NO.	DESCRIPTION	QTY.
1	276306	VERTICAL FOAM PAD, LEFT (9'H 20"P)	1
2	276307	VERTICAL FOAM PAD, RIGHT (9'H 20"P)	1
3	276313	HORIZONTAL FOAM PAD (8'/9'H 20"P)	1
4	276319	HARDWARE KIT	1

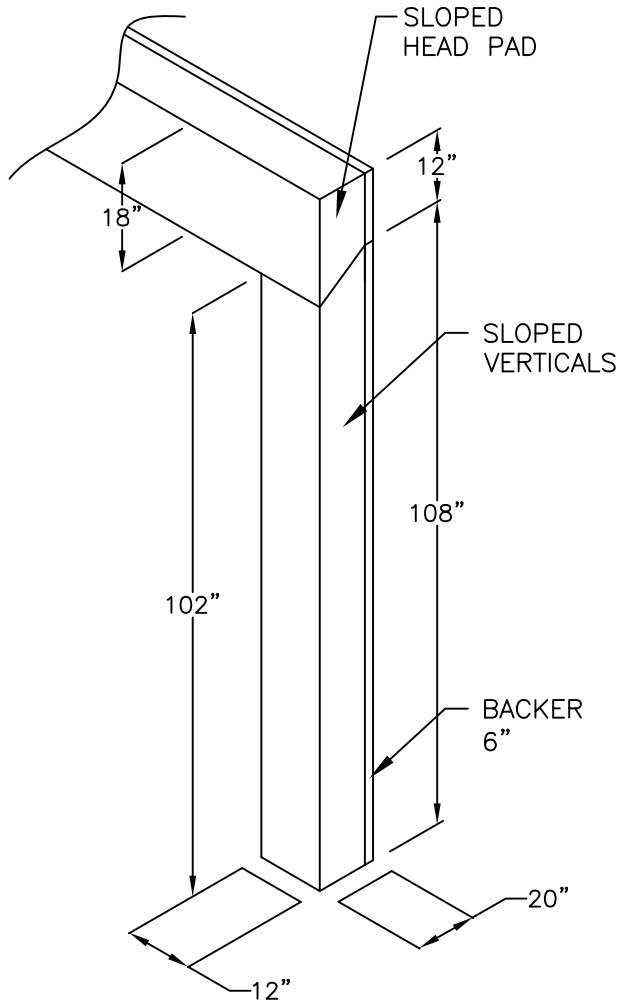

Wesco Dock Seals

- 40 oz high-tear-abrasion-resistant fabric.
- Double lock stitched seams.
- Kiln dried superior grade back lumber.
- 99% Memory Foam core for extended life.
- Fixed head pad provides maximum seal.
- Condensation drainage system.
- Full height yellow guide strips.
- Galvanized mounting hardware included.

Specs

Door Width: 96" (8')
 Door Height: 108" (9')
 Projection: 20"
 Weight: 300 lbs

THIS DRAWING IN ALL PARTICULARS IS WESCO INDUSTRIAL PRODUCTS, LLC PROPERTY. ALL RIGHTS OF DESIGN, INVENTION OR USE OF ARE RESERVED.

PRINT ISSUED

JUN-26-2020

WESCO MANUFACTURING
ENGINEERING DEPARTMENT

BS

APP

06-26-20
RELEASED FOR
PRODUCTION

ECN & DATE

REVISIONS

A

REV.

WESCO INDUSTRIAL PRODUCTS, LLC

NORTH WALES

PENNA. 19454

PART NAME

DS-96108-20
DOCK SEAL

DRAWN:

CHECKED:

APP. ENGR.

SCALE:

TOLERANCE UNLESS OTHERWISE SPECIFIED

FRACTION 3 PLACE DECIMAL 2 PLACE DECIMAL

± 1/64 ± .005 ± .01

ANGULAR ± 1-1/2' SHEET 1 OF 1

BREAK ALL SHARP EDGES AND REMOVE ALL BURRS

A-276053

REV

A