

260054

REPLACEMENT PARTS LIST
64"/68" Stacker

1	260143	CHAIN ROLLER ASS'Y	1
2	050771	LIFT CHAIN ASS'Y (64/68")	1
3	108519	STABILIZER ROLLER	4
	051617	STABILIZER ROLLER KIT	
4	108517	PLATFORM ROLLER	4
5	053769	WHEEL: 5x2, PHENOLIC ASS'Y	2
6	054265	CASTER: SWIVEL 4x2 PHENOLIC	2
7	150001	FLOOR LOCK: NEW STYLE	1
8	051161	JACK ASS'Y (64/68")	1
	052723	SEAL KIT	1
	050750	PUMPING PEDAL ASS'Y (PL/SPL)	1
	050752	RELIEF PEDAL ASS'Y (PL/STCKR)	1
	050774	PUMPING RELEASE VALVE KIT	1
	050468	MAGNET SPACER ASS'Y	1

STANDARD/ECONOMY LINE FORK MODEL HYDRAULIC STACKERS

- Floor locks, safety screen and foot guard are standard on all models.
- Forks touch the floor on all fork models.
- Front phenolic wheels are 5" diameter.
- Rear Phenolic swivel casters are 4" diameter.
- Hydraulic jack manufactured by WESCO in U.S.A
- Frame and lift heights vary among models.
- "S" tandard line features one piece platform guide rail.
- "E" conomy line offers an economical price value.

STRADDLE ECONOMY FORK MODEL

260054 ESFL-64-30S

Fork: 1" thick x 3" Wide x 30" long
 Lift Height: 64"
 Load Center: 18"
 Base leg span: 25.5" Inside
 32" Outside
 Capacity: 1,000 lbs
 Weight: 289 lbs
 Boxed: No

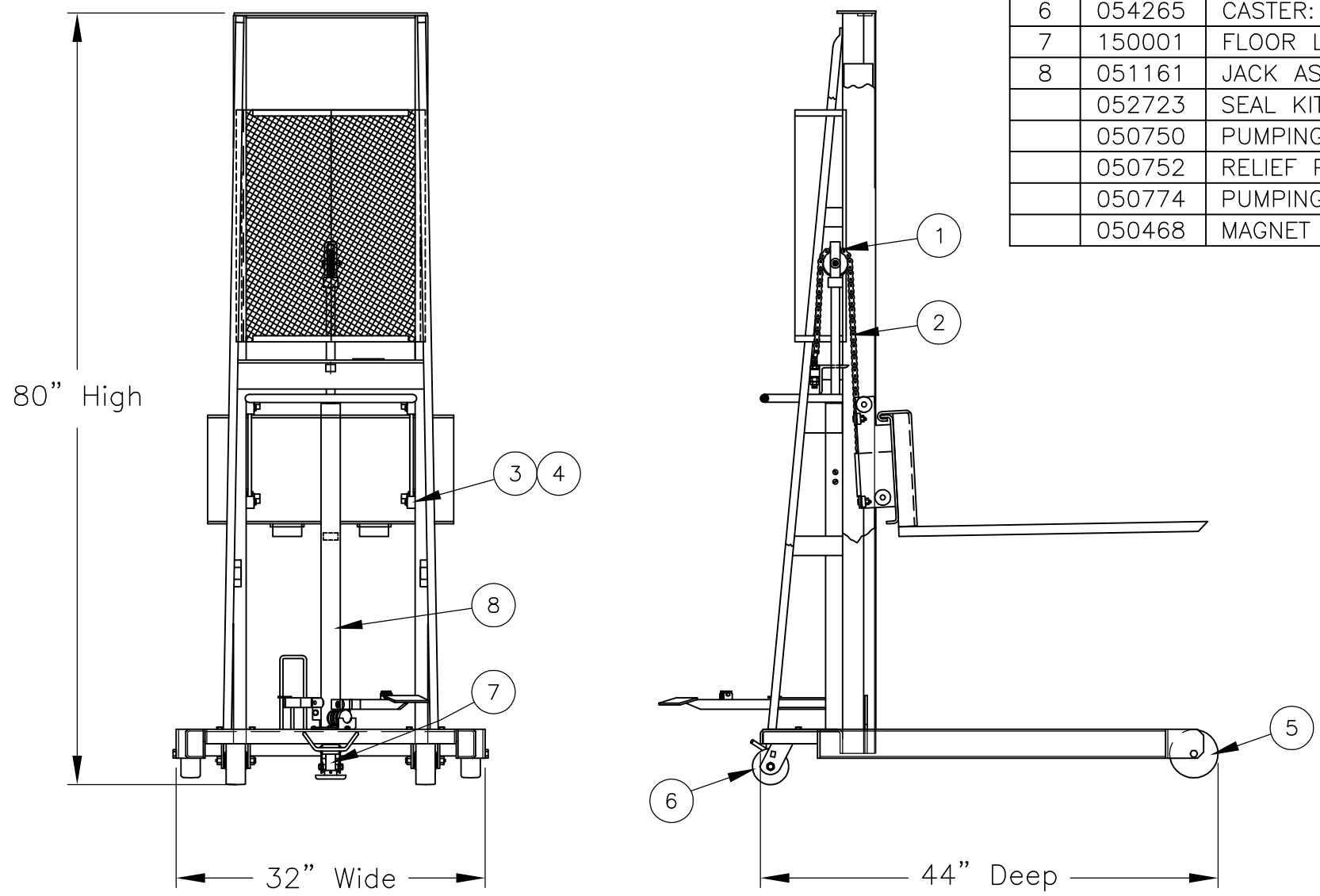

PRINT ISSUED
MAY 17, 2006
WESCO MANUFACTURING
ENGINEERING DEPARTMENT

WESCO INDUSTRIAL PRODUCTS INC.
LANSDALE PENNA. 19446

PART NAME		DRAWN: WEW 10-16-98	
ESFL-64-30S		CHECKED:	
TOLERANCE UNLESS OTHERWISE SPECIFIED		APP. ENGR.	
FRACTION	3 PLACE DECIMAL	2 PLACE DECIMAL	SCALE: 1" = 16"
± 1/64	± .005	± .01	B- 260054
ANGULAR ± 1-1/2'	SHEET 1	OF 1	
BREAK ALL SHARP EDGES AND REMOVE ALL BURRS			

APP
ECN & DATE
REVISIONS
REV.

REV