

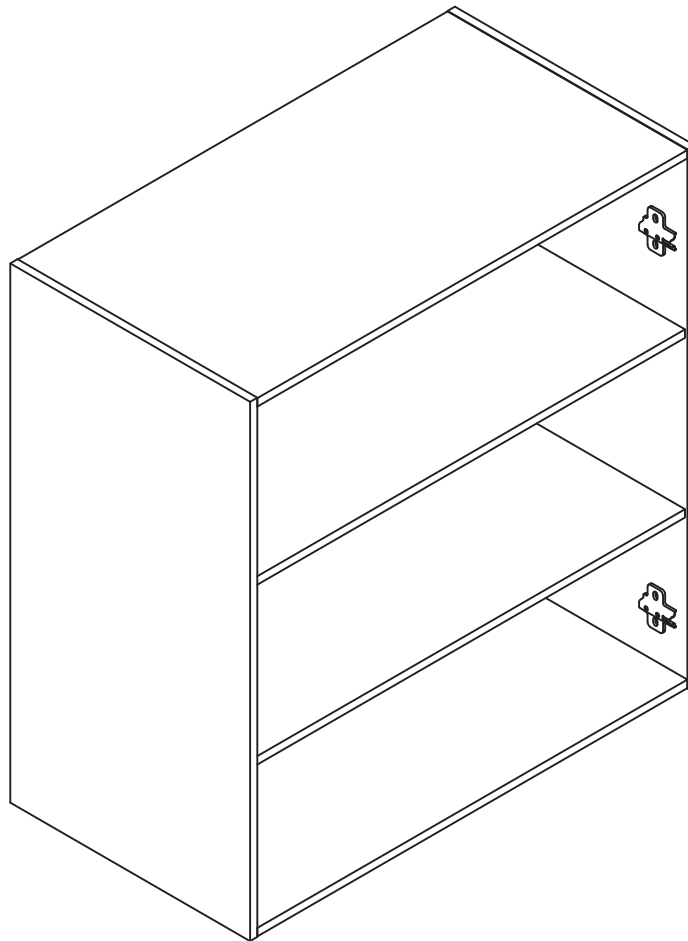









Mirella Series
Display Cabinet Case
Model No. MRSCC36

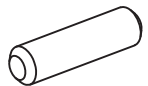



For questions or concerns, please call 1-888-971-6225 available
Monday-Friday 7:30 AM to 5:00 PM (Central Time)
(English-speaking operators)

PARTS LIST

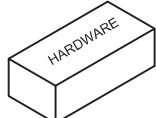
Name	Part	Qty.	Spare Qty
A	 HB Cam Post	18	1
B	 HB Wood Dowel	16	1
C	 HB Cam Lock	18	1
D	 HB Shelf Support	8	1

Name	Part	Qty.	Spare Qty
E	 HB Cam Sticker	18	1
F	 HB Ø35 Grommet	2	
G	 HB EVA 490*13*2mm	2	
	 HB MRSCC36		

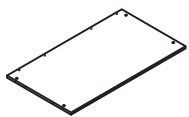
PARTS LIST

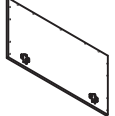
Name	Part	Qty.
H	 HB Top Panel	1
I	 HB Bottom Panel	1
J	 HB Left Side Panel	1

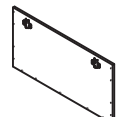
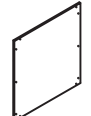
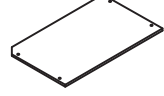
Name	Part	Qty.
K	 HB Right Side Panel	1
L	 HB Back Panel	1
M	 HB Adjustable Shelf	2

Items with HB are in hardware box.

IMPORTANT!

Review ALL instructions before beginning assembly. These instructions are provided to avoid problems that may occur from improper assembly or installation. SAFCO and/or its distributor are not responsible for failure resulting from improper assembly or installation of this product. Moreover, all warranties are void for failure to follow these assembly instructions.

- 1 Insert Wood Dowel (B) & Cam Post (A) to all panels. Install Cam Lock (C) to Panel (H&I&L). Fasten Top Panel (H) and Bottom Panel (I) to Back Panel (L), Install the Grommet (F) on the Back Panel (L), Attach the Cam Sticker (E) to cams;
Note: Wood dowels must be installed into the vertical panels, not the horizontal panels. Be sure dowels are in all the way.

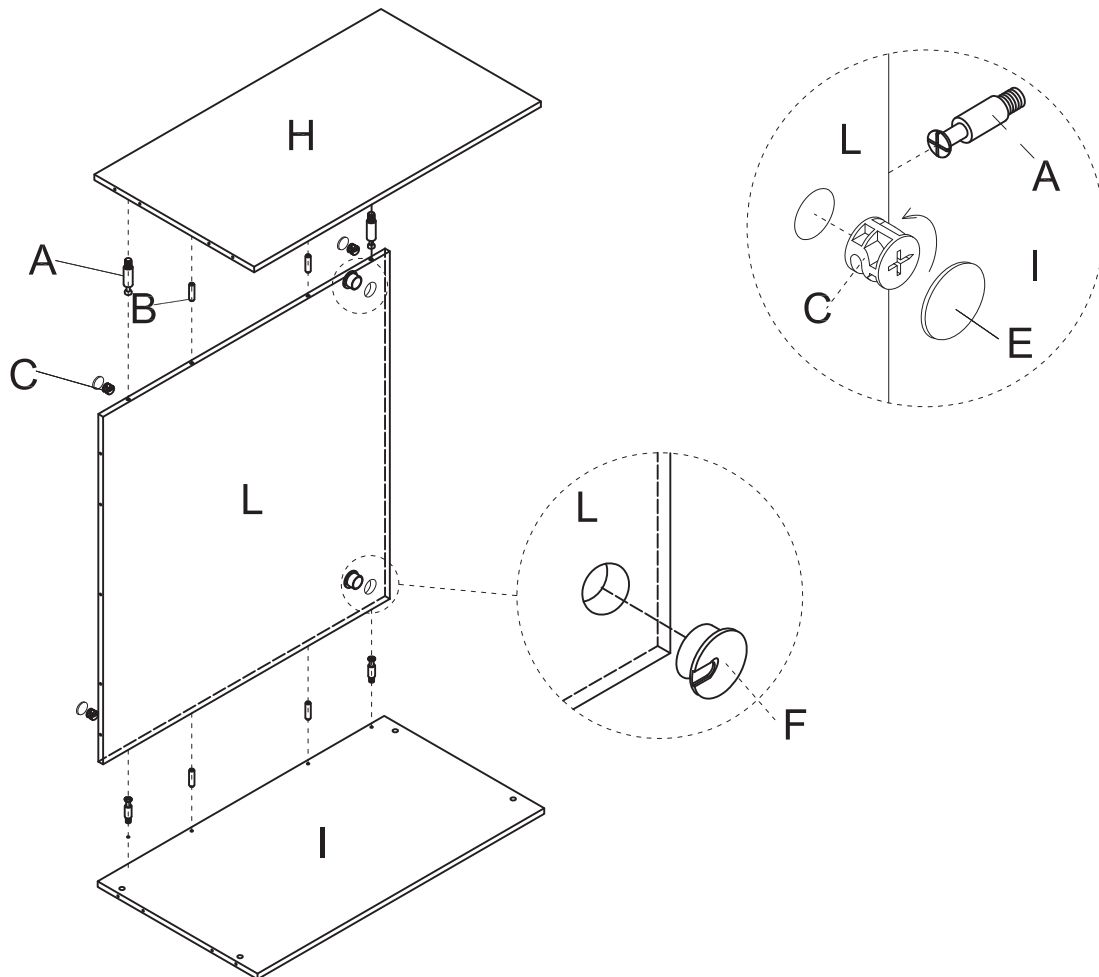

- 2** Fasten the Left Panel (J) and Right Panel (K) to the Top Panel (H), Back Panel (L) and The Bottom Panel (I); Attach the Cam Sticker (E) to cams;

Note: Wood dowels must be installed into the vertical panels, not the horizontal panels. Be sure dowels are in all the way.

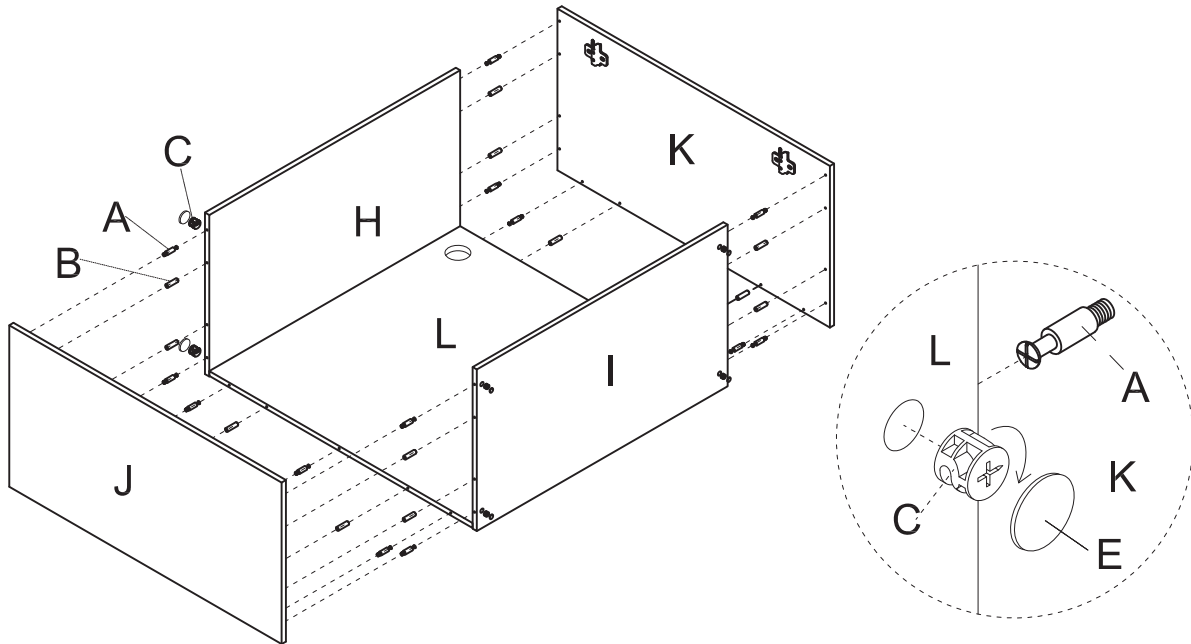

- 3** Insert Shelf Support (D) to the Side Panel (J&K), Put Adjustable Shelf (M) on the Shelf Support (D), Adhere EVA (G) on the bottom of Side Panel (J&K).

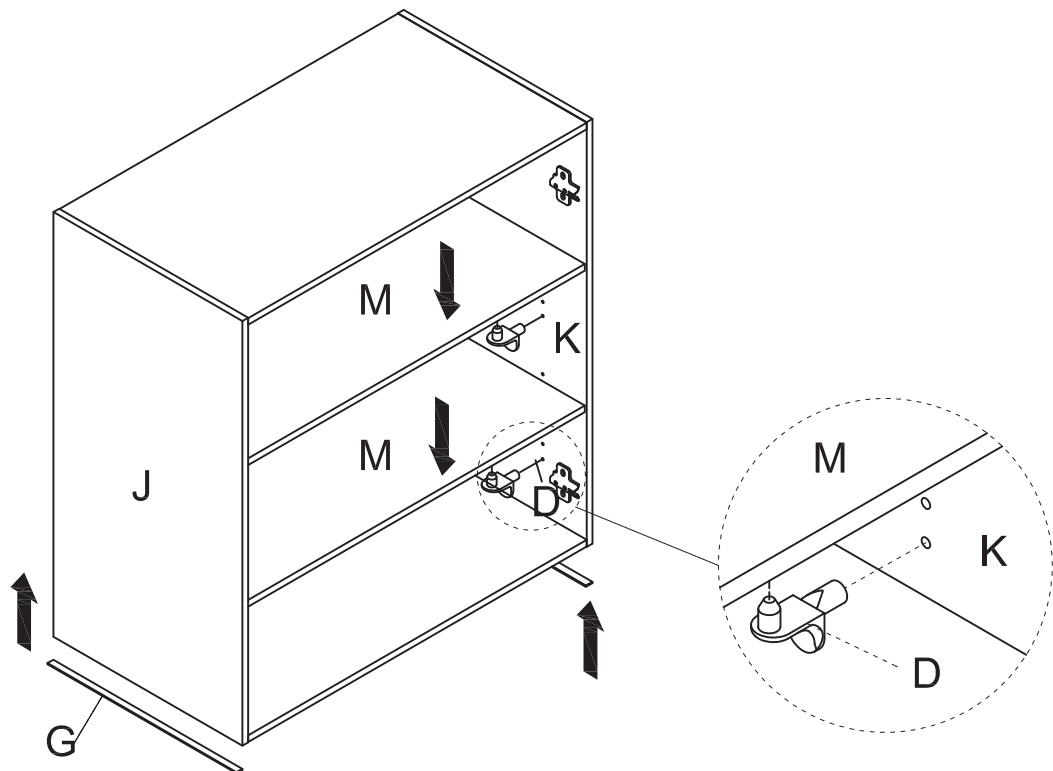

Pre-Installed Replacement Parts List

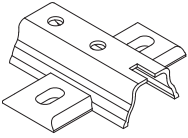
Part	Included Qty.
 Hinge Plate- Overlay	4

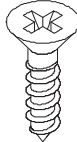
Part	Included Qty.
 Ø4X14mm White	16

