



OP-924 CRANE SCALE

USER'S MANUAL

(OP-924A, OP-924B Series)



TABLE OF CONTENTS

Safety Precautions.....	1
Preparations and Set Up.....	1
Features.....	2
Specifications.....	3
Power Supply.....	4
Displays.....	5
Display and Key Descriptions.....	6
Operating Instructions.....	7-98
Calibration.....	9-10
Scale Parameter Settings.....	11
Troubleshooting.....	12
Contact Us.....	12

SAFETY PRECAUTIONS

For safe operation of the weighing scale, please follow these instructions:

- Calibration inspection and maintenance of the scale are prohibited by non-professional staff
- Please ensure that the scale hangs securely
- The scale is a piece of static sensitive equipment; Please cut off power during electrical connections
- Touching the internal components by hand is prohibited
- DO NOT exceed the rated load limit of the unit
- DO NOT hang on the unit
- DO NOT use this product if any of the components are cracked
- DO NOT use for purposes other than weight taking
- To avoid damaging the battery do not keep charger plugged in once the battery is fully charged
- Make sure the weight is not over the Max capacity as it could damage the load cell inside
- Material that has a static electric charge could influence the weighing. Discharge the static electricity of the samples, if possible. Another solution to the problem is to wipe the scale with an anti-static agent

Please take anti-static prevention measures

Any accumulated charge on the body of the human operator should be discharged first before opening the protective container with ESDS devices inside. The discharge can be accomplished by:

- Putting a hand on a grounded surface or, ideally, by wearing a grounded Anti-static Wrist Strap and an Anti-static Mat

PREPARATION & SET UP

- Plug into a wall outlet to avoid interference with other wirings
- Turn on the scale while there is no load
- Calibration may be required before weighing when the scale is initially installed or moved from a location

FEATURES

- LED or LCD display option
- Multiple weighing units: kg/lb
- Gross/Tare/Hold/Zero
- Economical, light weight and hand held general purpose crane scale
- Features and easy to red backlit LCD or ultra bright LED display
- Powered using a rechargeable batter pack (up to 80 hours) and AC adapter
- The standard remote controller allows user to change units, clear measurements, zero and tare out weight
- Remote controller can capture peak weight at a distance of up to 100 feet (30m)
- Wireless remote control has Hold function
- Low battery reminder
- Automatic power off/power saving mode

Technical Parameters

- Accuracy class: Class III
- Tare Range: 100% max. capacity
- Initial Zero Range: $\pm 10\%$ max. capacity
- Manual Zero Range: $\pm 2\%$ max. capacity
- Zero Range: 45 F.S.
- Overload: 100 F.S.
- Display: 6 digit LED/LCD work height 1.5"
- Battery: 6V/10Ah, 6V/5Ah, or 6V/3.2Ah lead acid battery
- Charger: AC110V Input, DC9V/1500mA output
- Operation temperature: $-10\text{ }^{\circ}\text{C} \sim +40\text{ }^{\circ}\text{C}$
- Operation humidity: $\leq 90\%$ RH
- Storage temperature: $-40\text{ }^{\circ}\text{C} \sim +70\text{ }^{\circ}\text{C}$ (32-104°F)

SPECIFICATIONS

SCALE MEASUREMENTS

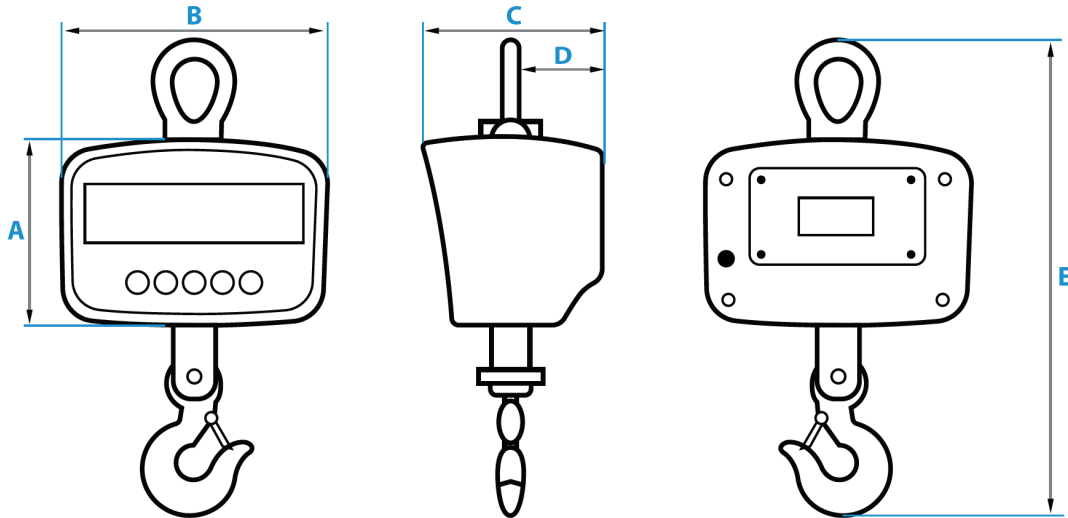

EXTERIOR DIMENSIONS				
A	B	C	D	E
5.88"	8.50"	5.75"	2.91"	15.16"-17.13"

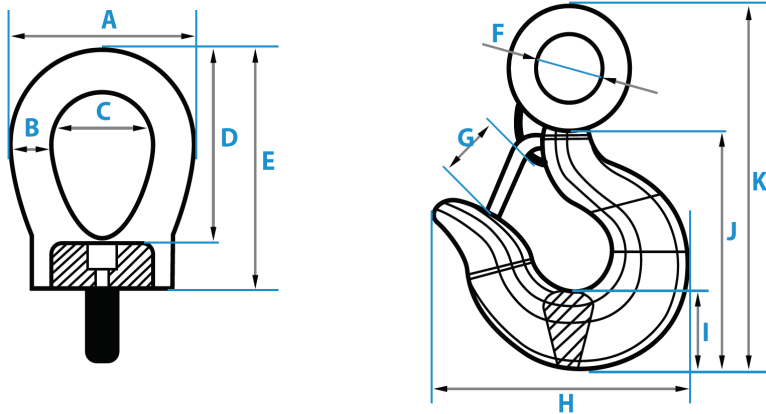

HOOK DIMENSIONS										
A	B	C	D	E	F	G	H	I	J	K
UP TO 2,000 LBS.										
2.55"	0.60"	1.35"	2.65"	3.25"	0.90"	0.90"	2.92"	0.96"	3.15"	4.92"
OVER 2,000 LBS.										
2.55"	0.60"	1.35"	2.65"	3.25"	1.22"	1.15"	3.57"	1.25"	3.90"	6.50"

POWER SUPPLY

AC Adapter

The scale is powered by an adapter, plug the adapter directly into the “DC” pin located at the back of the scale. We recommend to plug into a wall outlet to avoid interference with other wirings. A 110-220V AC adapter should be provided with your scale. Please use only the AC adapter provided to prevent damage to your scale.



Battery

OP-924 comes with a rechargeable battery, please charge the internal battery fully before first time use for 10-12 hours to prevent low voltage resulted from left leakage of battery. Once charged the battery should last for 45 hours. An AC adapter should be provided with your scale. Please use only the AC adapter provided to prevent damage to your scale. To keep the battery in best condition, fully discharge the battery every month by leaving the scale on until the scale powers off, and then recharge fully. If the battery is not going to be used for a long period of time it is recommended to remove it to avoid leakage.

On OP-924A

- When the Battery is low the battery scale light flashes red
- During charging the red light will stay lit

ON OP-924B

-  symbol will indicate battery's charge
-  symbol indicates that the battery needs to be charged



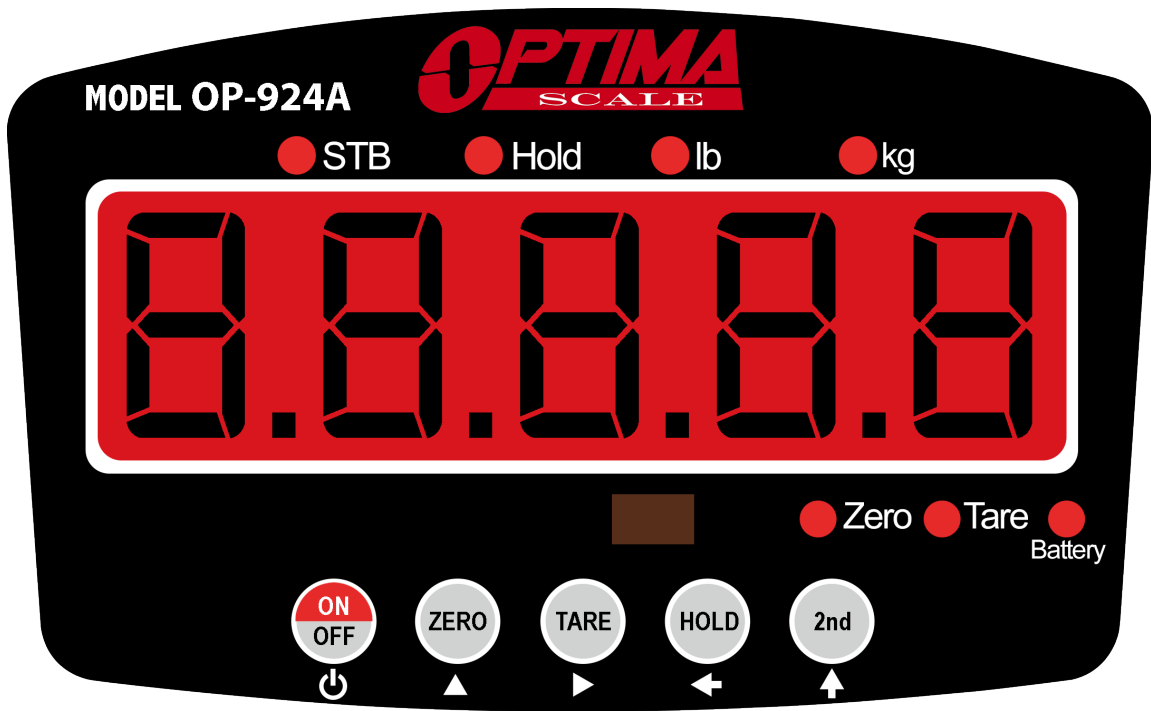

OP-924A (LED)

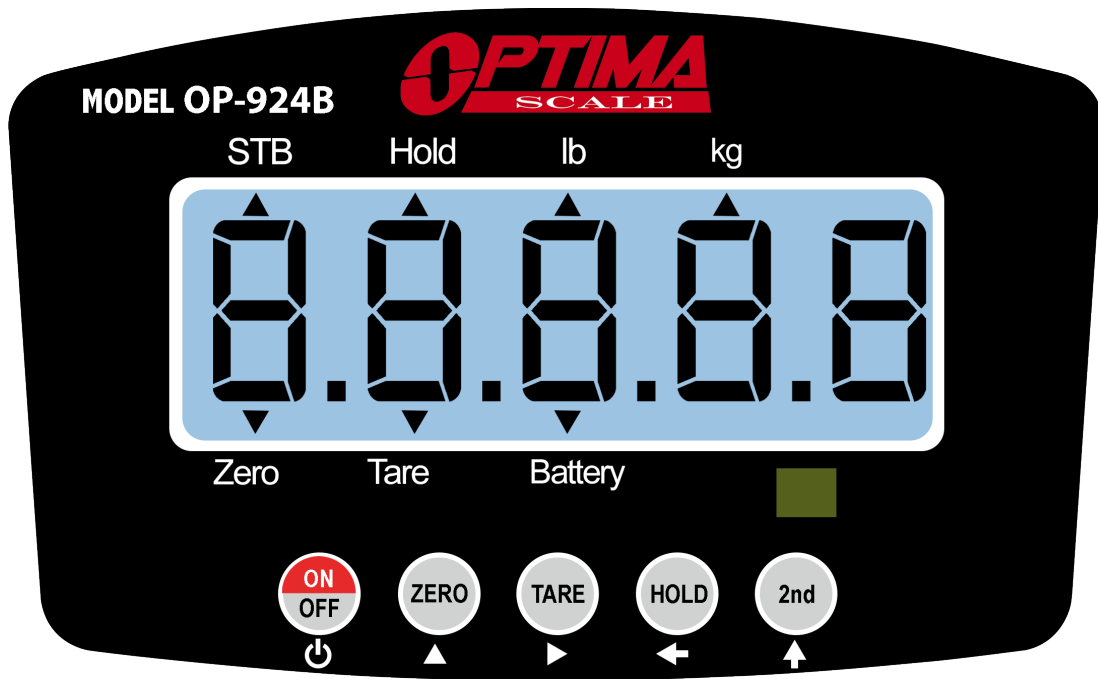











OP-924B (LCD)



DISPLAY AND KEY DESCRIPTION

ON/OFF	Powers the Scale On or Off if held for 2 seconds
ZERO	Zero's the scale
TARE	1. Resets the scale to zero when there is something on the scale 2. Clears the tare to see the gross weight
HOLD	Holds the weight
2ND	Enters 2nd Mode
STB	Shows that the weight is stable
hold	Shows you are in Hold mode
lb	The weight is shown in pounds
kg	The weight is shown in kilograms
Zero	Shows you have zeroed the scale
Tare	Shows you are in Gross weighing mode
Battery	Flashes red = low battery, Solid red = charging
	Power
	Up Arrow Key
	Right Arrow Key
	Return/Enter
	Enter 2nd Mode

REMOTE KEY DESCRIPTIONS					
KEY		Weighing Mode	2nd Mode	Data Input	Parameter Settings
		Turns off scale	Exit		Exit
		Zero	Unit change	Add 1	Page up
DEL		Clear last accumulation	Clear all the accumulations	Confirm	
		Hold	Parameter Setting		Enter to next step
		Tare	Preset tare weight	Cursor flashing to the right	
ACC		Accumulate		Reduce 1	Page down
F1		Check the accumulation	Check battery		
F2		Serial interface send the data once	Set the serial interface		
F3		Check the last weight	Check the internal code		
F4		Store the weight			
F5		Reserved			
					

OPERATING INSTRUCTIONS

Power On/Off



- Turn on the power by pressing the power  button for 2 seconds. Once on, the scale will flash the voltage and then begin to auto-check and count down from 0-9 sequentially before entering the weighing mode

Note: Anything on the scale before powering on will automatically be tared out.



Zeroing

- The zero function is used only when the scale is empty and is not at gross zero due to material build up (such as a chain or rope)
- Pressing the **ZERO**  key will reset your scale to 0
- Depending on what your manual zero range parameter is set to, you can zero out any number within your set selection, after that you will receive an error and will need to tare out the weight

Unit Selection



- To switch between measuring units (kg/lb) press the **2nd**  key followed by the **Zero**  key to switch between units

Tare Function

- The Tare function is used when you only wish to see the current change in weight, not the entire amount of weight that is on the scale
- When the scale is in gross mode pressing the **TARE**  key will Tare the current weight on the scale and enter the net mode
- For example if you are using a chain add the chain to the scale, press tare and the display will show the tare symbol  and reset back to 0
- Add your product to the scale to weigh without the weight of the chain
- To exit Tare mode press the TARE key again to enter gross mode and you will see the total weight of the container and the product

Note: If you remove the chain the scale will show the minus weight of the chain

To use a pre-set tare weight

- Press **2nd**  key, then press the **TARE**  key; the display should now show [00000]
- Using the arrow keys, input the tare weight value
- Press **Hold**  key to confirm and enter net weighing mode

Hold

Manual Hold: Grabs the current weight and holds it so it will not change/fluctuate.

- While weighing, press the **Hold** ◀ key and the scale will hold the current weight on the screen until HOLD is pressed again

Accumulation









- The accumulation function is used to add multiple weights and total them together
- In weighing mode load the first weight, once stable press the **ACC** ▼ button on the remote to enter the accumulation mode and accumulate the first weight
- The display should show [ACC] if it shows [noACC] then the weight exceeded the upper limit
- Remove your first load and add your second load to the scale; press **ACC** ▼
- Repeat previous step until all loads you want to accumulate have been added to the scale
- **Note:** In case of a mistake. Press **DEL** ◀ to clear the last accumulation data; the display should show [deL]; if not it will display [noDeL]
- Press **F1** to total your weights, the display should show [n###] (the number of weights you are adding together) then it will display the total accumulated weight for 3 seconds and return to weighing mode
- To clear the data, press the **2nd** ↑ key and the display should show [2nd], then press **DEL** ◀ to clear all the accumulation data, and the display should show [CLEAR]

Weight Display









- Press **F4**, the display should show [StorE], and save the current weight value
- Press **F3**, the display should show [LAsT0], use the arrow keys to choose a serial number (most recent weights save as 0, the first weight saves as 9)
- Press **HOLD** ◀ to display the corresponding weight for 2 seconds, then it will go back to the weighing mode

OP-924

CALIBRATION PROCEDURE

1. Power on the crane scale
2. Press **2nd**  key and the display should show [2nd]
3. Press **2nd**  key again and the display should show [PASS-] then [00000]
4. Use the arrow keys   to enter the password "07650"
5. Press the **HOLD**  key to confirm
6. A password error above will make the scale return to weighing mode, while a correct password will let the user continue to set units, limits and perform calibration
7. Next the display should show [Un kg], which means the units is set to KG
8. Press the **ZERO**  key to change the display to [UN Lb] and then press **HOLD**  to confirm. It should now show [FS 0#], referring to the table below
9. User can press **ZERO**  to change the setting and **HOLD**  to confirm

Display	Max. Cap	Division	Min. Calibration Weight needed
FS 0.1	500 lb	0.1 lb	50 lbs
FS 0.2	1,000 lb	0.2 lb	100 lbs
FS 0.3	1,500 lb	0.2 lb	150 lbs
FS 0.5	2,000 lb	0.5 lb	200 lbs
FS 01	3,000 lb	0.5 lb	300 lbs

10. The display should show [CALOn]; Press **HOLD**  to enter calibration mode or press  to exit calibration mode
11. If calibration mode is entered, then it should display [LoAd0] for zero calibration; with no load on the scale, wait for the stable light to turn on, then press **HOLD**  to confirm (scale may take a few minutes to fully stabilize)
12. The display should show [0] to complete zero calibration. Press  to exit calibration mode or press **HOLD**  to continue
13. If continued the display should show [LoAd1] for loading a calibration weight; after 2 seconds the display should show [00000]; Using the arrow keys  , enter the calibration weight that you will be using (remember that you need at least 10% of the max capacity you set, but the more the better)
14. Add the calibration weight to the scale
15. Wait for the stable light to turn on and press **HOLD**  to confirm
16. The display should now show [EnD]; Press **HOLD**  to return to weighing mode
17. If the display does not show the value of the calibration weight you used, the scale will need to be calibrated again







OP-924











GRAVITATIONAL ACCELERATION FACTOR CORRECTION

1. During calibration, when the display shows [CALon], press **TARE** ► to enter into gravitational acceleration factor correction
2. It defaults to 1.0000 and controls the relationship to the weight in direct proportion
3. Use the arrow keys ▲► to modify the parameters then press **HOLD** ◀ to confirm
4. The display should now show [EnD], press **HOLD** ◀ to confirm
5. **Note:** after weight calibration, the gravitational acceleration factor reverts to the default value of 1.0000. If the work site is lack of weights, press modify the gravitational acceleration factor to adjust the weight.

SCALE PARAMETER SETTINGS

To enter calibration/parameter settings, follow the procedure below:

1. Power on the crane scale
2. Press the **2nd**  key and the **HOLD**  key at the same time the display should show [2nd]
3. Press the **HOLD**  key to confirm and enter into the next step
4. Use the arrow keys   to change the parameter settings
5. Press the **ON/OFF**  key to save and exit settings at any time

Function	Parameter	Settings/Options	Default
Display Division		0.02 = 0.02 kg/lb 0.05 = 0.05 kg/lb 0.1 = 0.1 kg/lb 0.2 = 0.2 kg/lb 0.5 = 0.5 kg/lb 1 = 1 kg/lb 2 = 2 kg/lb	1
Automatic Power Off		0 = turn off auto power off 10 = power off automatically if no change within 10 min. 30 = power off automatically if no change within 30 min. 60 = power off automatically if no change within 60 min. 90 = power off automatically if no change within 90 min.	10
Power Saving Mode (idle mode)		0 = turn off power saving setting 10 = turn off display if no change within 10 minutes 30 = turn off display if no change within 30 minutes 60 = turn off display if no change within 60 minutes 90 = turn off display if no change within 90 minutes	30
Kg/LB Conversion		0 = turn off kg/lb conversion 1 = turn on kg/lb conversion	1
Manual Zero Range		0 = turn off manually zero setting and initial zero setting 1 = Initial zero range $\pm 10\%$ max capacity Manual zero range $\pm 2\%$ max capacity 2 = Initial zero range $\pm 100\%$ max capacity Manual zero range $\pm 100\%$ max capacity	2
Filter Intensity		0 - turn off filter intensity 1 = weak 2 = moderate 3 = strong	1
Stable Intensity		0 = weak 1 = moderate 2 = strong	1
Warning Tone		0 = turn off warning tone 1 = turn on warning tone	1
Display Brightness		1 = light 2 = moderate 3 = dark	1
Zero Tracking Speed		0 = no zero tracking 1 = $\pm 0.5\%$ max capacity 2 = $\pm 1\%$ max capacity 3 = $\pm 2\%$ max capacity 4 = $\pm 5\%$ max capacity	

TROUBLESHOOTING

Checking the Battery Life

Press **2nd** ↑ then press **F1**, the display should show [U 6.##] battery power level for 2 seconds and then go back to weighing mode

Internal Code Checking

Press **2nd** ↑ and the display will show [2nd], then press **F3** to display the internal code, only used in maintenance and debugging.

To exit press 2nd key and the display will show [2nd], then press **F3** to go back to weighing mode

Screen Display and Instructions

Error	Reason	Solution
Err6	Exceed zero range	Check the crane load
U 628	Battery Power	
uuuuu	Overload	
nnnnn	Lower than the minimum value	Reduce the weight
2nd	2nd mode, wait for combination key	
oFF	Power off	
ACC	Accumulate	
noACC	Cannot be accumulated	
dEL	Clear the last accumulation value data	
nodEL	Cannot be cleared	
CLEAR	Clear all the accumulation data	
StorE	Save the display value data	
LAST0	Check the weight serial number	

CONTACT US

Please e-mail sales@optimascale.com for any sales related questions.

Please e-mail support@optimascale.com for any support related questions.

Don't forget to visit our website at:

optimascale.com