

## RCLMHEX PET Wall Panels Installation Instructions

Tools Required: None

**IMPORTANT:** For best results:

- Allow recommended time for adhesive strips to attach to PET panels before affixing them to a wall (spring, summer, autumn = 12-24 hours, winter = 48-72 hours).
- Ensure wall is clean, dry, flat, and dust-free before attaching panels.
- Indoor use only at temperatures between 50°F and 100°F (10°C and 38°C).
- Do not use outdoors or in damp or high humidity locations.
- Do not use on wallpaper, damaged walls, or damaged glass.

### Parts Key

#### 6-Pack

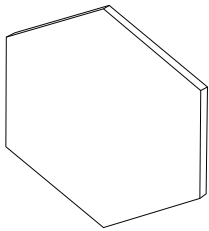

Hexagon PET Panel  
Thick x 3

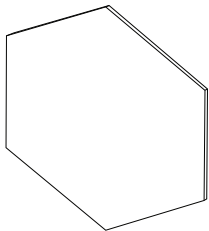

Hexagon PET Panel  
Thin x 3

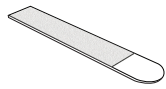

Adhesive Strip  
Fabric Side x 12

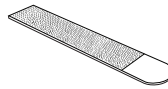

Adhesive Strip  
Hook Side x 12

#### 12-Pack

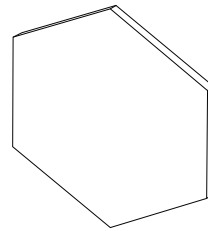

Hexagon PET Panel  
Thick x 6

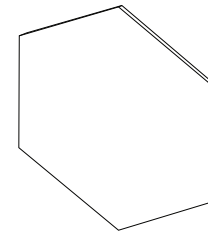

Hexagon PET Panel  
Thin x 6

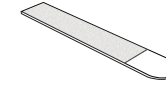

Adhesive Strip  
Fabric Side x 24

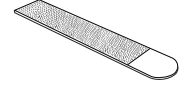

Adhesive Strip  
Hook Side x 24

- 1** Remove protective film from two fabric side adhesive strips.  
**IMPORTANT:** Do not touch the adhesive.

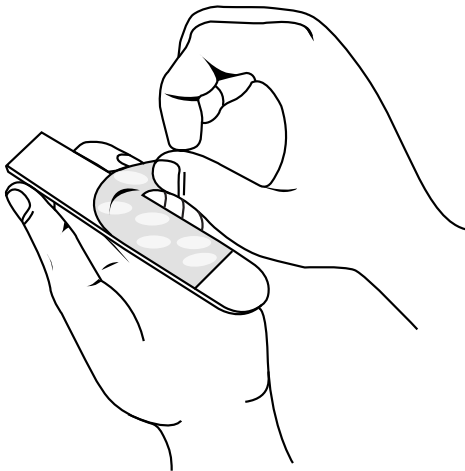

- 2** Stick both fabric strips to one side of a PET panel as shown.

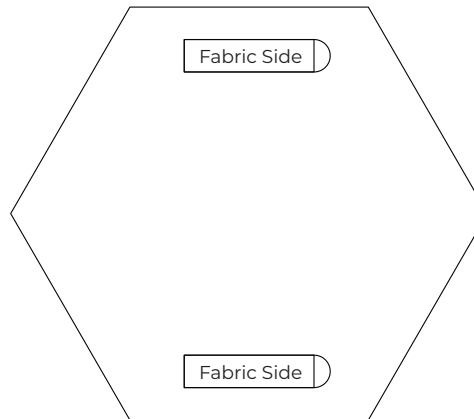

**NOTE:** Both sides of each panel are identical, so it does not matter which side the adhesive strips are attached to.

- 3** Press firmly and hold 30 seconds.\*

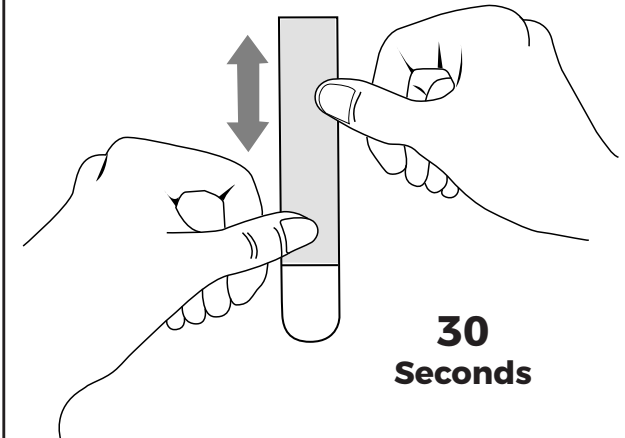

\* For best results, wait 12-24 hours (during spring, summer, autumn) or 48-72 hours (during winter) before proceeding to step 4.

## RCLMHEX PET Wall Panels Installation Instructions

Tools Required: None

- 4** Attach the hook side adhesive strips to the fabric side strips currently attached to the panel.

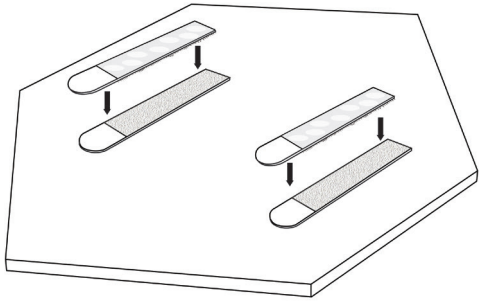

- 5** Remove protective film from the adhesive side of two hook and loop strips.

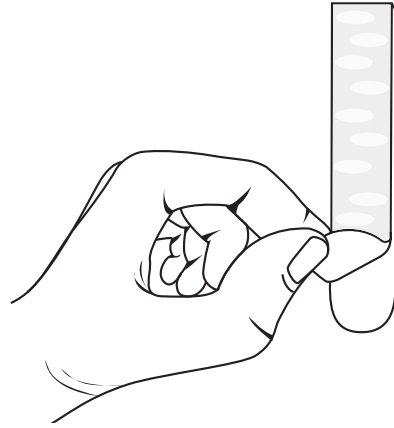

**IMPORTANT:** Do not touch the adhesive.

- 6** Stick the PET panel to your desired location on a wall.\*



\*For best results, ensure wall is clean dry, flat, and dust-free before affixing panels.

- 7** Press firmly and hold 30 seconds.

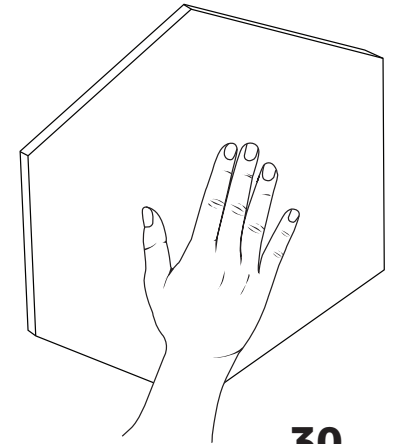

**30  
Seconds**

### Pattern Ideas

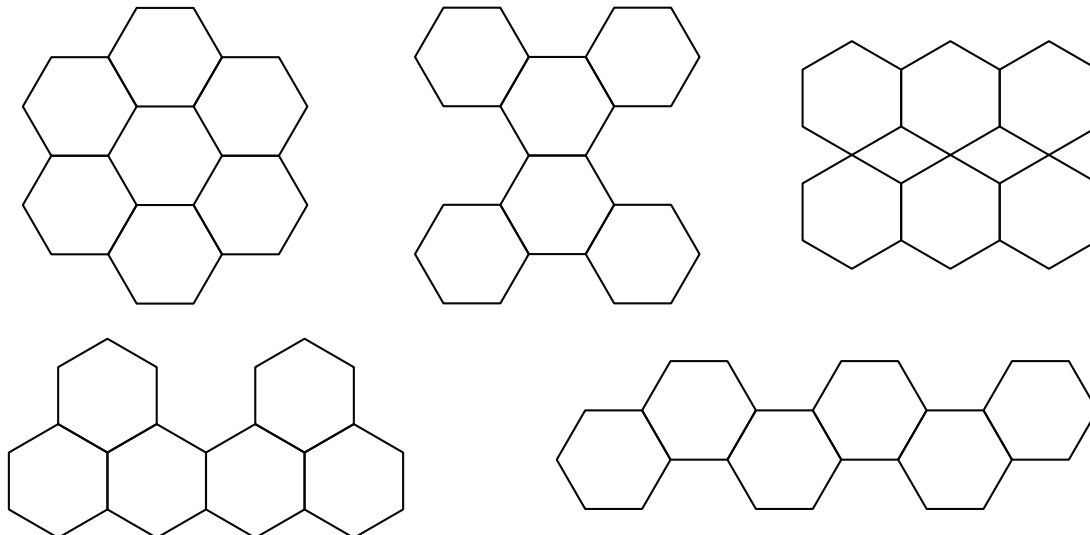

### Removing Adhesive Strips from a Wall

1. Firmly hold the strip with one hand.
2. Grab the tab with your other hand.
3. SLOWLY pull the tab parallel with the wall, away from the strip.
4. Keep the tab as close to the wall as possible (NEVER pull away from the wall).
5. The adhesive layer will slide out from behind the strip, detaching the strip from the wall.

**NOTE:** Adhesive strips are not reusable.