

HEAVY-DUTY MOBILE WORKSTATION – Assembly Instructions

Tools Required:

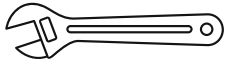

Adjustable wrench

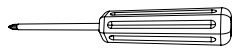

Phillips Screwdriver

Parts Key



1 x44
M8x16mm



2 x16
M8x55mm



3 x16

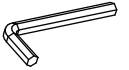

4 x1

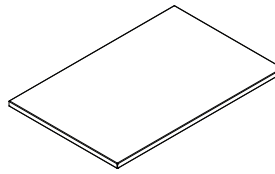
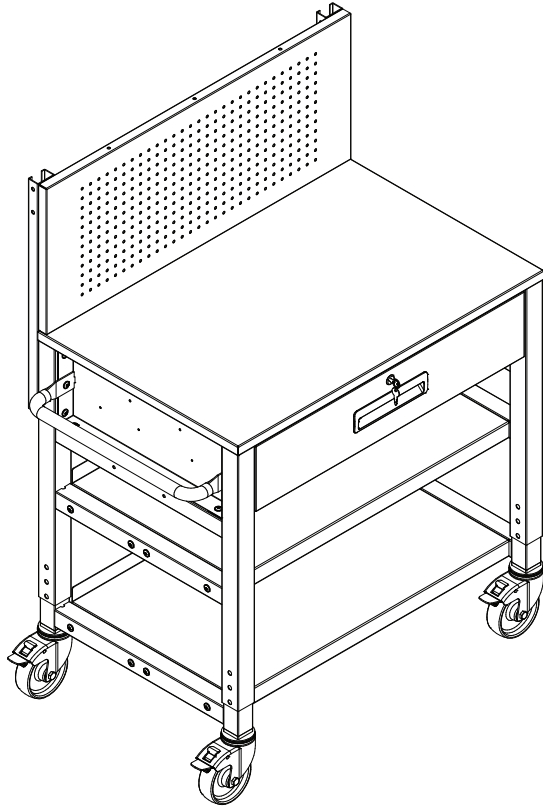

A (1PC)

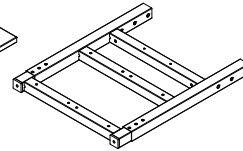

B (2PCS)

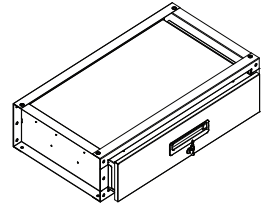

C (1PC)

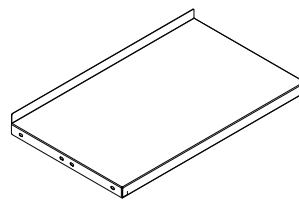

D (2PCS)

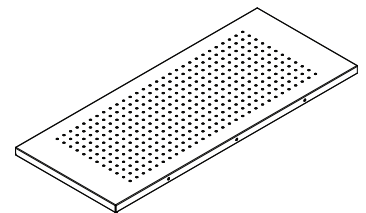

E (1PC)

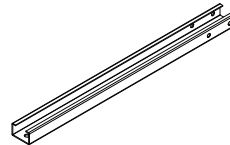

F (2PCS)

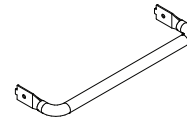

G (1PC)

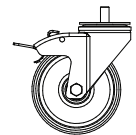

H (4PCS)

