

DAHLE[®]

707 PS

PAPER SHREDDER

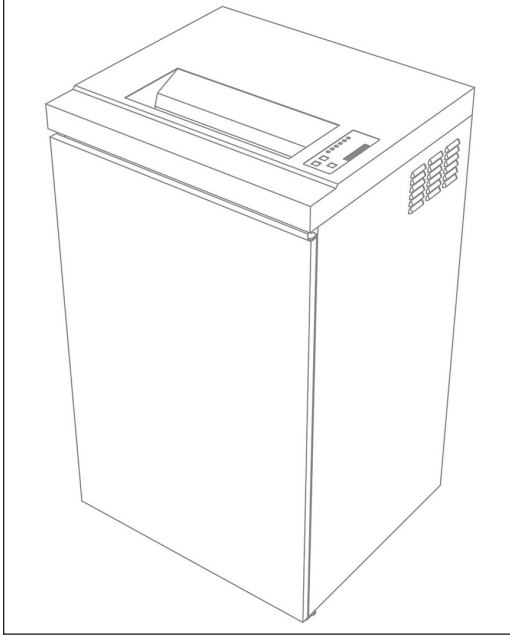

Operating Instructions

Dahle 707PS

DAHLE[®]

TABLE OF CONTENTS

CONTENTS	PAGE
Safety Precautions.....	3-4
Installation	4
Operation	5
Auto Oiler	6
Maintenance	6
Warranty	6
Troubleshooting	7

READ CAREFULLY BEFORE USING

Proper care of your new shredder will ensure many years of trouble free operation, with minimum of maintenance or repair.

IMPORTANT:

Please note that all packaging should be retained by the customer for (30) days from the time of receipt. In the event that this unit needs to be sent back for replacement or repair this packaging will be required to do so. Should the packaging have been discarded before the (30) day requested period, packaging costs may be incurred by the customer.

SPECIFICATIONS

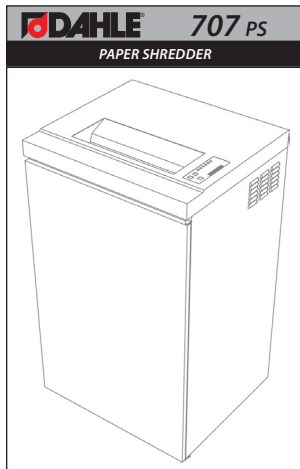

Security Level:	P-7 (NSA/CSS O2-01)
Shred Size:	1 mm x 5mm
Feed Width:	16"
Sheet Capacity:	11 / 13 sheets
Bin Capacity:	53 gal.
Warranty:	2 yrs. shredder / 1 yr. cylinders
Dimensions:	21.75" X 28" X 43"
Weight:	320 lbs.
Power Supply:	115v 50/60 Hz 15 Amp

*Results may vary depending on power source, paper type, and proper maintenance.
Warranty includes labor but excludes wearable parts.*

IMPORTANT SAFETY PRECAUTIONS

Your new shredder features powerful cutting mechanisms that may cause serious injury. Please follow all safety precautions.

- Only store, transport, and operate the shredder in an upright position!
- All liquids and gases used on the shredder must comply with Dahle guidelines!
- The shredder must only be operated in enclosed spaces at temperatures of 15 °C to 32 °C (59 °F–90 °F) and non-condensed humidity of 15% to 95%!
- Do not place the shredder near a heat source!
- Ensure the shredder is firmly on the floor at a distance of 4" from the wall; activate caster locks!
- Avoid any accumulation of heat!
- The mains socket must be grounded and easily accessible at all times!
- Use only the power cord supplied with the device by Dahle and ensure that it is not damaged!
- Ensure that the building installation has short-circuit protection: max. 16 A (US max. 20 A)!
- Do not use near flammable liquids and gases!
- Do not use near caustic substances!
- Do not subject to moisture!
- Do not open up the machine!
- Automatic start-up!
- Switch off the shredder at the main switch when not in use!
- Only use the shredder provided that it is in perfect working order, while observing the operating instructions and the usual regulations, guidelines and applicable safety and accident prevention requirements. Take the shredder out of service immediately if faults occur!
- The device is not intended for use by persons (including children) with restricted physical, sensory or mental capabilities or a lack of experience and knowledge, unless they are working under supervision or receive detailed instruction about how to use the device from a person who is responsible for safety.

IMPORTANT SAFETY PRECAUTIONS

1. It is obligatory to follow the safety instructions!
2. Read the operating instructions carefully before using the shredder!
3. This shredder is not intended to be used by children (the product is not a toy)!
4. Do not touch the feed opening with your hands!
5. Do not allow items of clothing to touch the feed opening!
6. Do not allow your hair to touch the feed opening!
7. Prior to maintenance work, disconnect the shredder from the power supply!
8. Remove paper clips and staples before shredding!

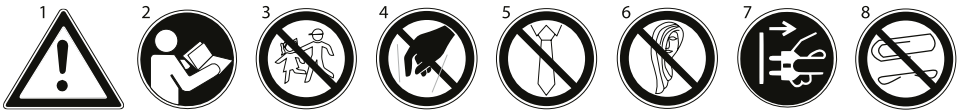

INSTALLATION

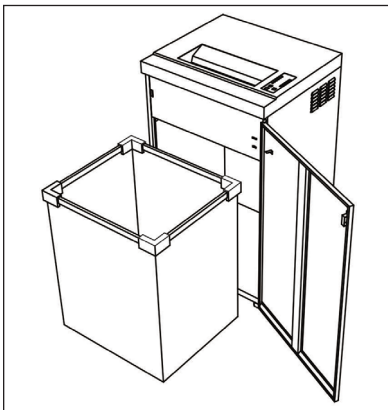

- Insert supplied waste bin into the shredder.
- Plug shredder directly into a wall outlet. Do not use a power strip or extension cord.

OPERATION

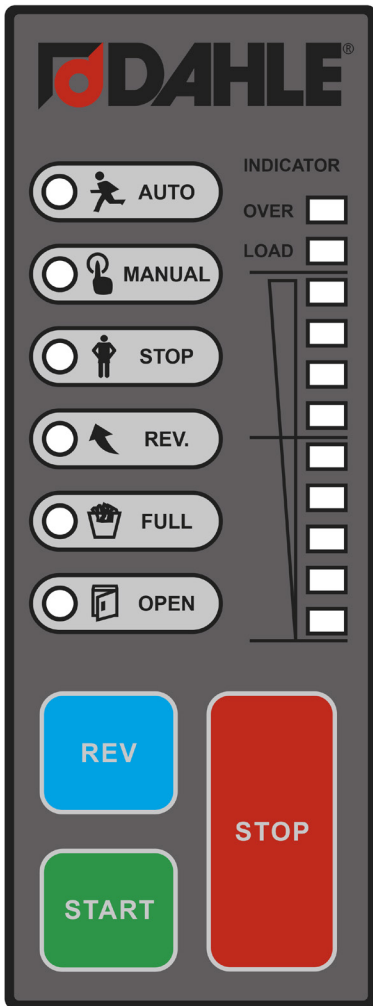

POWER ON

- Turn the main power switch ON (located on the right side of the shredder).

AUTO START/STOP

- Press the START button. The AUTO LED will illuminate indicating the shredder is ready for use.
- When in AUTO mode, the shredder will start and stop automatically when shredding.
- AUTO mode switches off after five (5) minutes of no activity.

MANUAL MODE

- With the AUTO button illuminated, push the START button again. The MANUAL LED will illuminate, and the shredder will begin to run. Press the START button again to turn off Manual mode.

REVERSE MODE

- Pushing the REV button will illuminate the REV LED and the shredder will operate in reverse. If too much paper is inserted into the shredder it will automatically operate in reverse. When this occurs, remove the paper and re-insert into the shredder in smaller quantities.

BAG FULL

- When the waste container is full, the FULL LED will illuminate, and the shredder will stop automatically. Open the door, remove and empty the waste container. Replace the waste container, close the door, and press the START button to resume shredding.

OPEN

- When the door is open the OPEN LED will illuminate and the shredder will not operate. Close the door to resume shredding.

AUTO OILER



This shredder is equipped with an auto oiling system. This system is designed to pump the optimal amount of oil onto the cutting blades at specific time intervals. Please make sure the oil container stays full and use only Dahle branded oil. Use of other oil may void warranty and cause damage to the shredder. To add oil follow the following steps:

- Remove hose and cap and fill existing bottle with Dahle shredder oil.
- Insert hose and cap into the bottle.

MAINTENANCE

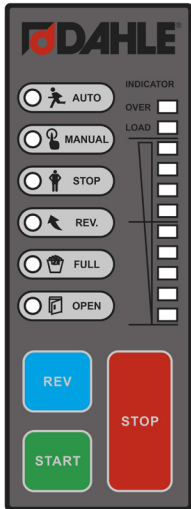

- After emptying the waste container, we recommend to press and hold the REV button for 5 seconds to initiate a cleaning cycle. This cleaning will take 1 minute and the machine will return to AUTO mode when complete.
- Switch off the shredder and disconnect power by removing power cord from wall outlet.
- Clean the exterior of the machine with a soft cloth. Do not use harsh detergents or chemicals.





WARRANTY

Dahle guarantees its industrial shredders to be free from manufacturing defects (materials / workmanship) for a period of two years. Dahle offers a one year guarantee on the cutting cylinders.

This warranty shall not apply to wearable items or defects caused by ordinary wear and tear, insufficient maintenance or improper operation. This warranty applies to the original purchaser only and is not transferable. There are no other warranties expressed or implied beyond the face of this agreement.

TROUBLESHOOTING

Easy check points before you report malfunction.

Symptoms	Check Point	
1. The paper shredder is not working. 2. Auto LED light is off	<ul style="list-style-type: none"> - Check the power plug - Check the voltage of the outlet (AC 120V or 220V it depends on your country's voltage rate) - Check the fuse which is located just below the main switch. 	 <p>120V</p> <p>Confirmation</p>
3. The paper shredder does not reverse and just stops when it's fed too much paper.	<ul style="list-style-type: none"> - Press the reverse button and clear the jammed paper then re-operate the paper shredder. 	
4. When the waste basket is full, the shredder is not working.	<ul style="list-style-type: none"> - Clear the waste basket then check that the Full LED light is off 	<p>Clear</p> 
5. Cabinet door is closed but the Door LED & Stop LED lights are still on	<ul style="list-style-type: none"> - Check the main switch which is located on the right top side. 	<p>Switch</p> 



Dahle North America, Inc.

49 Vose Farm Road

Peterborough, NH 03458

Tel. (800) 995-1379

info@Dahle.com



www.dahle.com

Version 4/2019