

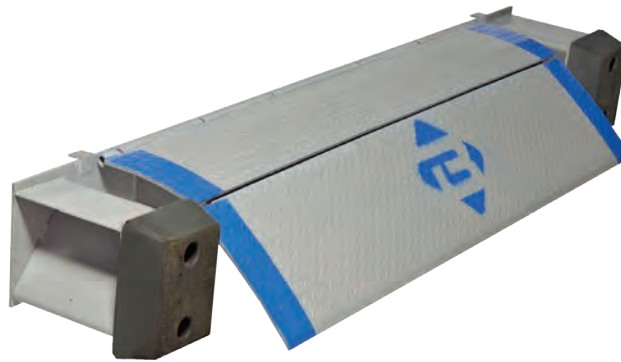

OWNER'S MANUAL AND INSTALLATION GUIDE FOR EZ-PULL EDGE-OF-DOCK LEVELER (EP)

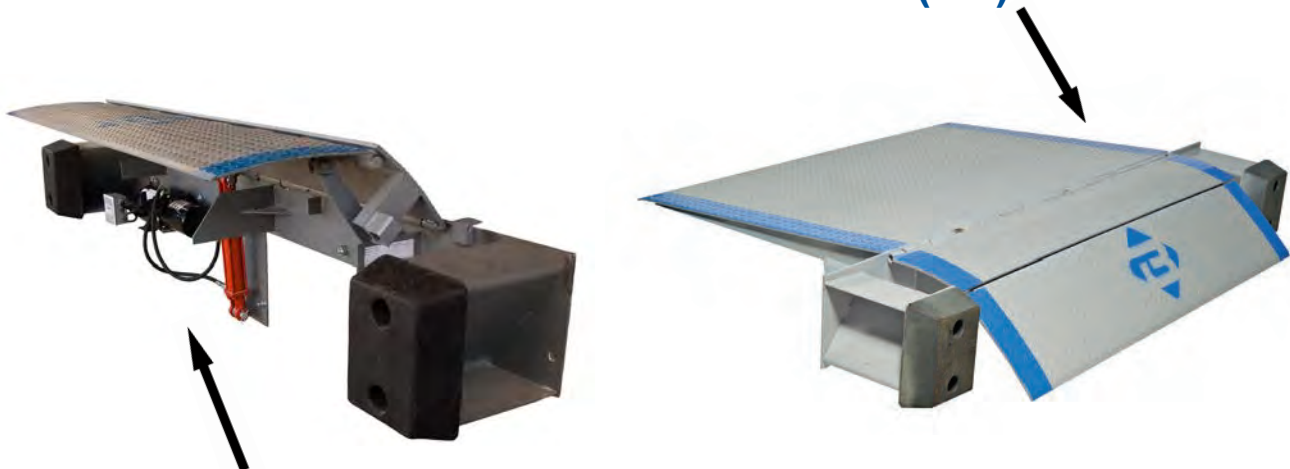



EP HYDRAULIC OPTION FOR EZ-PULL EDGE-OF-DOCK LEVELER (EP) OR LO-DOCK LEVELER(LD)



HYDRAULIC RETRO-FIT OPTION

SERVICE YOU CAN STAND ON



WARNING	⚠ CAUTION
	
<p>READ AND FOLLOW ALL SAFETY INSTRUCTIONS. FAILURE TO DO SO MAY RESULT IN INJURY OR EVEN DEATH.</p>	<p>USE CAUTION WHEN OPERATING UNIT. FAILURE TO DO SO COULD RESULT IN INJURY OR DAMAGE TO PRODUCT.</p>

DO NOT INSTALL, OPERATE OR SERVICE PRODUCT WITHOUT READING AND FULLY UNDERSTANDING ALL SAFETY PROCEDURES, WARNINGS, INSTALLATION AND OPERATING INSTRUCTIONS ENCLOSED IN THIS MANUAL.

TABLE OF CONTENTS

EZ-Pull Edge-of-Dock Leveler Owners Manual	3
Engineering Design.....	2
Dock Parameters	2
Product Specifications & Features.....	4
Safety Precautions	5
Tool List	6
Type I Installation Instructions for Edge-of-Dock Leveler.....	6
Type II Installation Instructions for Edge-of-Dock Leveler.....	8
Operating Instructions.....	10
Maintenance	11
Troubleshooting	11
Assembly Drawing	12
EPHYDRAULIC Option for EZ-Pull Edge-of-Dock Leveler (EP) or Lo-Dock Leveler (LD)	13
Installation Instructions for Factory Issued Hydraulic Unit	14
Wiring Schematic	15
Operating Instructions.....	18
Troubleshooting Guide	19
Hydraulic Retro-Fit Option for EZ-Pull Edge-of-Dock Leveler (EP) or Lo-Dock Leveler (LD)	20
Installation Instructions for In-Field Retro-Fit of Existing Leveler Unit	20
Bluff Warranty and Returned Goods Authorization	22



EZ-PULL EDGE OF DOCK LEVELER

OWNERS MANUAL*

*Read entire manual prior to unit installation.

Engineering Design

The Bluff EZ-Pull dock leveler design offers a tremendous ergonomic solution when compared to other available dock leveler designs. The simple, smooth performance and easy to position design eliminates the lifting and difficult positioning factors associated with hook type designs.

The Bluff latch assembly allows the operator to easily position the unit. A pull and push action on the EZ-Pull handle activates the unit, moving the lip forward onto the trailer floor. Retraction and storage of the unit after use is also accomplished by a pull and push action on the EZ-Pull handle. Simply pull the handle back until the leveler lip is removed from the trailer floor and then push the handle forward to allow the unit to store.

Dock Parameters

The EZ-Pull dock leveler will accommodate a maximum of five (5) inches above dock and five (5) inches below dock, providing 18.5% grade down and 20% grade up. This is acceptable for most gas or propane forklifts but is not suitable for most pallet trucks or many electric forklifts.

- Freight trailers range in height from 46 to 56 inches; therefore the EZ-Pull leveler should be mounted at 51 inches above the driveway.
- Refrigerated trailers range in height from 50 to 60 inches; therefore the EZ-Pull leveler should be mounted at 55 inches above the driveway. In addition, this application requires a Reefer Lip (17' lip length) to accommodate the offset floor of the trailer.
- Flatbed trailers have a wide range of trailer heights. Dock boards or other equipment may be needed for extreme height variations.
- Containers have variations in both floor heights and door configurations.
- Captive fleets require mounting midway between lowest and highest trailer, provided ± 5 " range is maintained.

Pallet trucks and electric forklifts can be used with trailers three (3) inches above and three (3) inches below dock level. Dock boards or other equipment may be needed to accommodate a greater service range for pallet jacks and electric forklifts. This is due to limited clearance and gradeability of that equipment.

EZ-Pull Dock Levelers WILL NOT accommodate refrigerated and freight trailers at a single dock location due to limitations specified above.

Solutions:

1. Mount separate EZ-Pull levelers at different heights to handle both types correctly.
2. Mount an EZ-Pull leveler with Reefer Lip at 55 inches and use Bluff Wheel Risers to raise low trailers to proper height.

Declining and inclining drives require special dock specification. Call for more information.

Product Specifications & Features

The Bluff EZ-Pull dock leveler is designed with a fully hinged lip and utilizes a torsion spring counterbalance assembly for ease of positioning. Unit conforms to ANSI Standard MH 30.1.

Three piece steel construction. Lip and ramp are constructed of 50,000 psi yield strength steel tread plate.

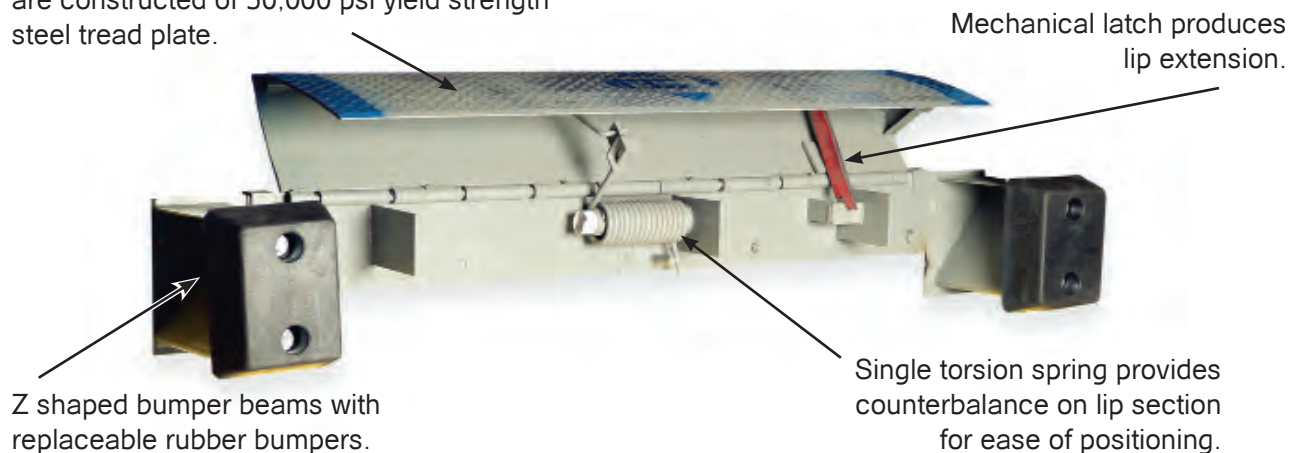

- Bluff's EZ-Pull leveler has 5 inches above and below dock surface operating range for propane and gas trucks and 3 inches above and below dock surface operating range for pallet jacks and electric forklifts.

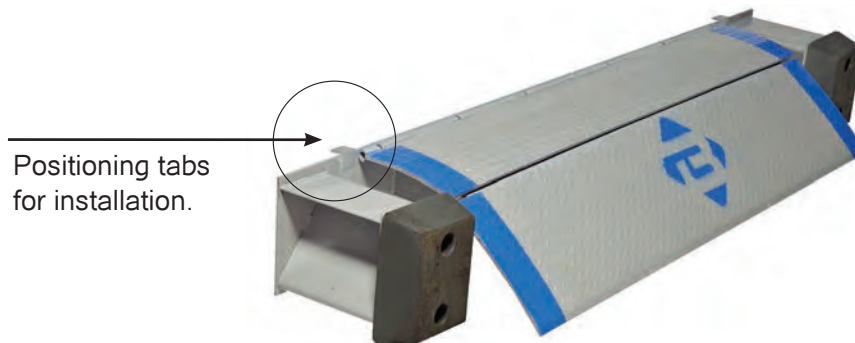

- Lip section tilts up to 1 inch for out of level compensation.
- Unit is also designed to float allowing for vertical corner deflection when the lip is in contact with truck bed.
- Positioning tabs ensure correct height placement on dock surface during installation, effectively making the Bluff leveler the **EASIEST TO INSTALL IN THE INDUSTRY**.
- One year structural warranty as defined on page 22.



Safety Precautions

READ AND UNDERSTAND ALL SAFETY PRACTICES AND OPERATING INSTRUCTIONS before installing, servicing or operating the dock leveler. Failure to do so could result in damage to unit, to property, and personal injury to operator.

1. Do not stand between leveler and trucks backing up to dock.
2. Do not operate the leveler with equipment, material or people on the deck section of the leveler.
3. Do not stand or travel across leveler unless lip is placed securely on truck bed floor.
4. Never attempt to work under the dock leveler without properly securing the front and center sections.
5. Keep clear of dock leveler while in operation.
6. Do not exceed capacity rating.
7. If dock leveler is not operating normally, discontinue use. Request maintenance personnel to inspect and contact your local Bluff dealer if necessary.
8. Keep clear of all pinch points that could cause injury.
9. Do not use leveler if it appears to be damaged or broken.
10. Damage to leveler could occur if product is misused or used in an abusive manner.
11. For additional information or concerns, contact your local Bluff representative.



EZ-PULL EDGE OF DOCK LEVELER

Tool List:

• Heavy duty drill	• Philips screw driver
• 5/8" masonry bit	• Small sledge hammer
• 8-12" adjustable wrench	• Portable mig welder
• 1/2" open end wrench	• Pliers

Type I Installation Instructions
Mechanical Edge-of-Dock (EP)

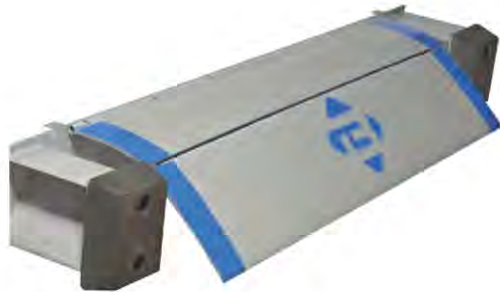

TYPE I: Dock edge with imbedded steel channel.

CAUTION: STAND CLEAR OF UNIT WHEN CUTTING STEEL BANDING.

NOTE: REMOVE HANDLE AND BUMPERS BEFORE BEGINNING THE INSTALLATION.

Handle is attached to mount plate for shipping purposes only.

1. Check straightness of embedded channel with a plumb line. If out of alignment shimming may be required. Any out of alignment condition will result in a binding problem.
2. Clean and prepare dock surfaces for installation.
3. Center the EZ-Pull leveler against the dock with the positioning tabs (see page 4) resting on top of embedded channel.

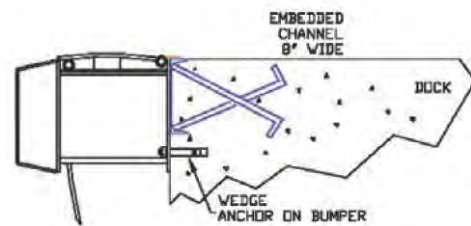
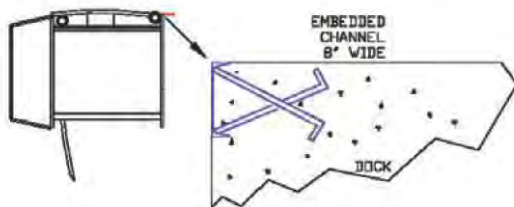

4. Tack weld mount plate alternating from right and left of center tack point and the vertical sides of the mount plate to the embedded channel.
5. Shim where necessary to keep leveler straight and plumb.
6. Tack weld mount plate alternating from right and left of center tack point and the vertical sides of the mount plate to the embedded channel.
7. Weld out the top of the mount plate from center out to the edges and down the vertical sides.

8. Position the bumpers flush with top of mount plate and butted up to the sides of the mount plate.



9. Mark the bottom hole location of bumper beam, drill an anchor hole and install a $\frac{3}{4}$ " x 4" wedge anchor bolt.
10. Re-position the bumper on the dock and weld to embedded channel and secure the bottom of the bumper anchor bolt and nut.



11. Re-grease the unit as welding may burn out some grease in hinge tubes.
12. Re-paint any burned areas. Rustoleum smoke grey (7786) or blue (7727) aerosol.
13. The latch is factory installed with notch against mount plate. Latch should swing freely when leveler is in its rest position.

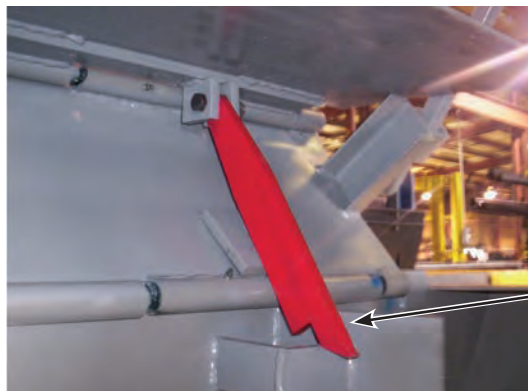

Latch Position
 (Indicated in red
 for clarity)

14. Remove bolt from bottom of handle and position handle into sleeve with bend facing away from dock face. Re-install bolt and nut into bottom of handle.
15. Test unit for correct operation. (See operating instructions for mechanical levelers.)

Type II Installation Instructions

Mechanical Edge-of-Dock (EP)

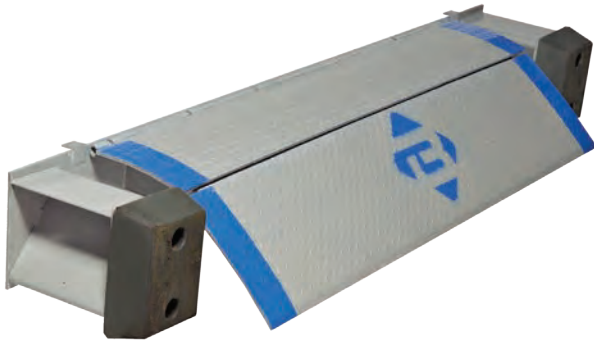

TYPE II: Dock edge without imbedded steel channel.

CAUTION: STAND CLEAR OF UNIT WHEN CUTTING STEEL BANDING.

NOTE: REMOVE HANDLE AND BUMPERS BEFORE BEGINNING THE INSTALLATION.

Handle is attached to mount plate for shipping purposes only.

1. Docks without imbedded steel channel require the installation of an approach plate, such as the Bluff EPAP12 model, in conjunction with a leveler unit.
2. Center the beveled approach plate in the desired location flush with the dock face. Cut if required to fit door opening.

An approach plate requires 5 heavy duty expansion shield anchor bolts with ½" flat head socket cap screws such as can be found in Bluff EP Kit 2. Locate the approach plate and drill pilot anchor holes with a 9/16" concrete drill bit. Remove approach plate and drill over pilot holes with a 7/8" concrete bit. Install expansion shield into holes (insert with threads on bottom). Re-position approach plate and anchor.

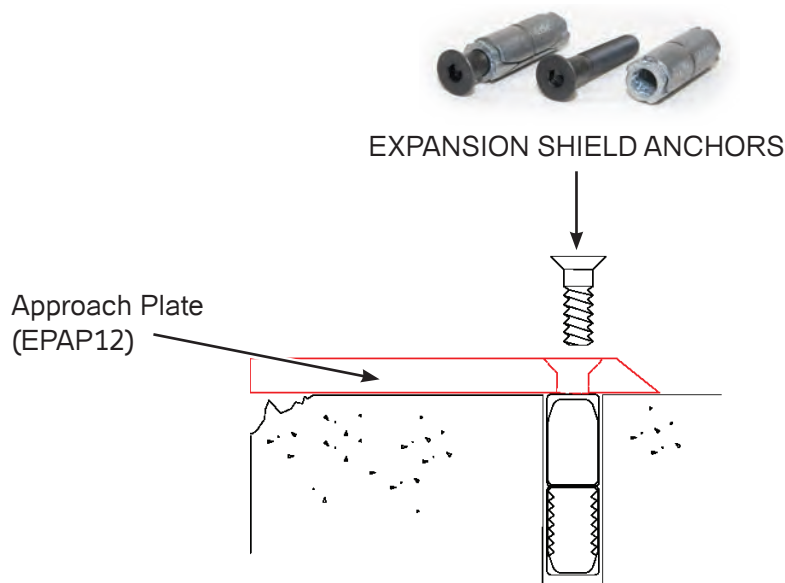

3. Center the EZ-Pull leveler against the dock with the positioning tabs (see page 4) resting on top of the approach plate.
4. Tack the top of the mount plate at the center to the approach plate.
5. Make certain that the leveler is straight and plumb (shim as necessary).
6. Drill 3/4" anchor holes along the mount plate and install 5 each 3/4"x 4" wedge anchors.

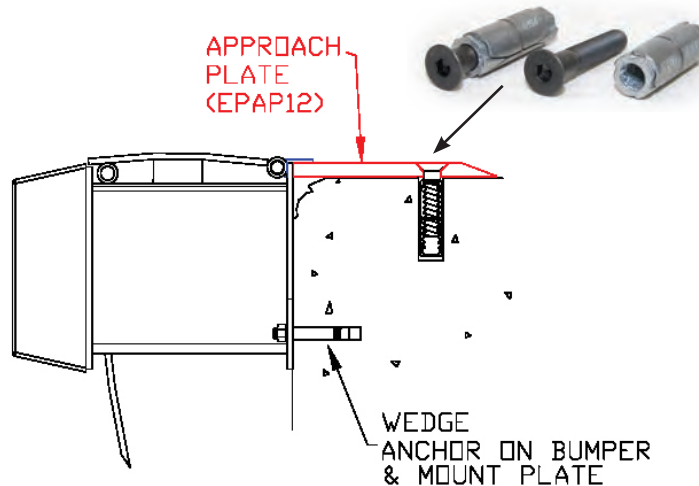

7. Weld top of mount plate to approach plate with a continuous weld from center out.
8. Remove weld slag and re-grease as needed as welding may burn out grease from hinges.
9. Re-paint any burned areas. Rustoleum smoke grey (7786) or blue (7727) aerosol.
10. The latch is factory installed with notch against mount plate. Latch should swing freely when leveler is in its rest position.

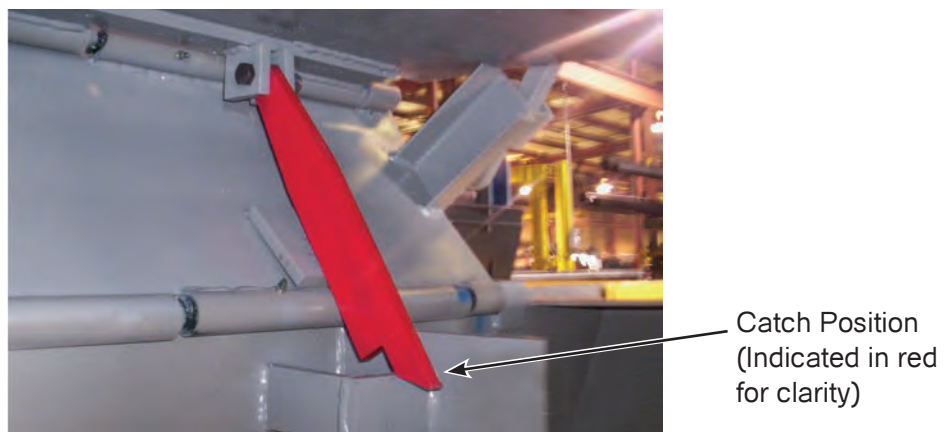

11. Remove the bolt from the handle and position it into sleeve tube with bend facing away from dock face. Re-install bolt and nut into bottom of handle.
12. Test unit for proper operation. (See operating instructions for mechanical levelers.)

Mechanical EDGE-OF-DOCK or LO-DOCK Operating Instructions



Step 1: Pull the EP handle up until the dead bolt hits the bottom of the 2-inch-square tube sleeve.

Step 2: Pull the handle back until the latch mechanism falls into catch position.

Step 1



Step 2a



Step 2b



Latch Position
(Illustrated in red for clarity)

Step 3: Push the handle forward to extend the unit outward toward the truck bed.

Step 3



Step 4: Continue to push forward until the front lip rests fully on the truck bed.

Step 5: Return the handle to its rest position while in use.

Step 6: When returning the unit to its stored position, repeat **Step 1**.

Step 7: Pull back the handle until the front lip clears the truck floor then allow the weight of the leveler to drop the unit into its rest position.

Step 8: Return the handle to its rest position.



Maintenance

The Bluff EZ-Pull Leveler will provide years of efficient operation if properly maintained. Preventive maintenance should be performed every six months or as needed for normal usage. For efficient operation and proper maintenance of Levelers used for multiple shifts (above normal usage), maintenance should be performed every 30 days.

1. **Cleaning:** Check hinge tube areas for any debris. Clean hinges with wire brush to remove any foreign objects.
2. **Grease:** The unit should be greased twice a year or as needed – grease zerts are located underneath the deck of the leveler.
3. **Structural Check:** Check unit over for any obvious structural wear. Check hinge tubes for any signs of cracking or wearing.
4. **Spring Assembly:** Check spring assembly to assure a proper float in the leveler deck. Check spring linkage rod for any signs of bending.
5. **Handle Check:** Check EZ-Pull handle for any signs of bending or cracking. Improper handle bend may result in unit not latching properly.
6. **Latch:** Check the latch and latch catch for signs of wear on surfaces. Too much wear can decrease height up allowance and may keep latch from disengaging.

Any damaged parts should be replaced immediately and can be purchased from your local Bluff distributor. Bluff levelers feature a modular design, allowing for easy replacement.

Troubleshooting

The Bluff EZ-Pull Edge of Dock Leveler is a mechanical device requiring leverage and gravity to operate efficiently.

1. ***When I raise the dock leveler, the front lip does not extend outward.***
 - Check to ensure latch is attached to unit.
 - Check to ensure latch notch is facing the dock.
 - Check latch assembly for damage or excessive wear.
2. ***When I raise the dock leveler, the handle hits the dock surface.***
 - Check to ensure handle is located correctly in holster. Handle and bend facing away from dock face (toward trailer) when stored in position.
 - Check handle for damage.
3. ***The leveler will not raise enough to allow latch to catch.***
 - Check for proper tube clearance. Tubes should be 1/8+" higher than dock surface. Deck needs to rotate to approximately the one o'clock position.
 - Check handle for any damage.
 - Check hinge tubes for any debris. Wood, nails, etc. can prevent proper rotation.
4. ***The leveler is difficult to raise and lower in position.***
 - Check hinge tubes. Clean any debris or foreign objects from hinges. Use wire brush if necessary.
 - Check hinge tube lubrication. Grease unit thoroughly.

****Important: Specify Model Number and Serial Number when ordering parts***

Assembly Drawing

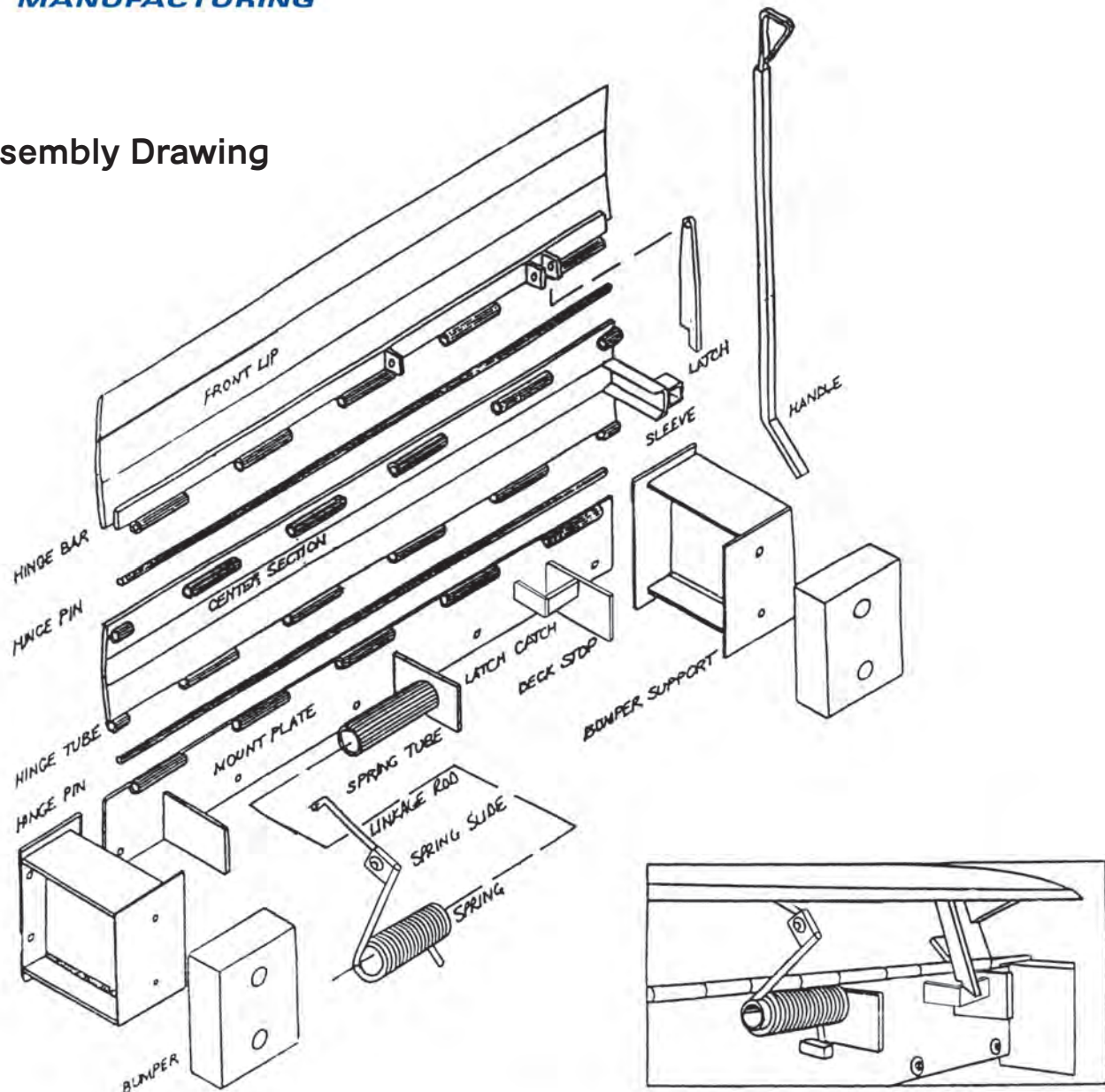

**Important: Specify Model Number and Serial Number when ordering parts.*

PART #	ITEM DESCRIPTION
EP72LIP	EZ-Pull Front Lip Assy (Std) – 15" Lip Length
EP72LIPR	EZ-Pull Front Lip Assy (Reefer) – 17" Lip Length
EP72DECK	EZ-Pull Center Section Assy
EPBUMPBASE	EZ-Pull Bumper Support
EPSA	EZ-Pull Spring Assy (includes Linkage Rod)
EPRB10	EZ-Pull Molded Bumper – 13" x 10" x 4" w/Fasteners
EPLINKROD	EZ-Pull Linkage Rod w/Pins
EPHANDLE	EZ-Pull Handle w/Bolt
EPLAT	EZ-Pull Latch w/Bolt
EPCB10	EZ-Pull Bumper Complete w/Base

INSTALLATION GUIDE FOR EPHYDRAULIC OPTION for Bluff EDGE-OF-DOCK and LO-DOCK Levelers

MHYDCYLINDER
Fully extended: 22.25"
Closed: 16.25"

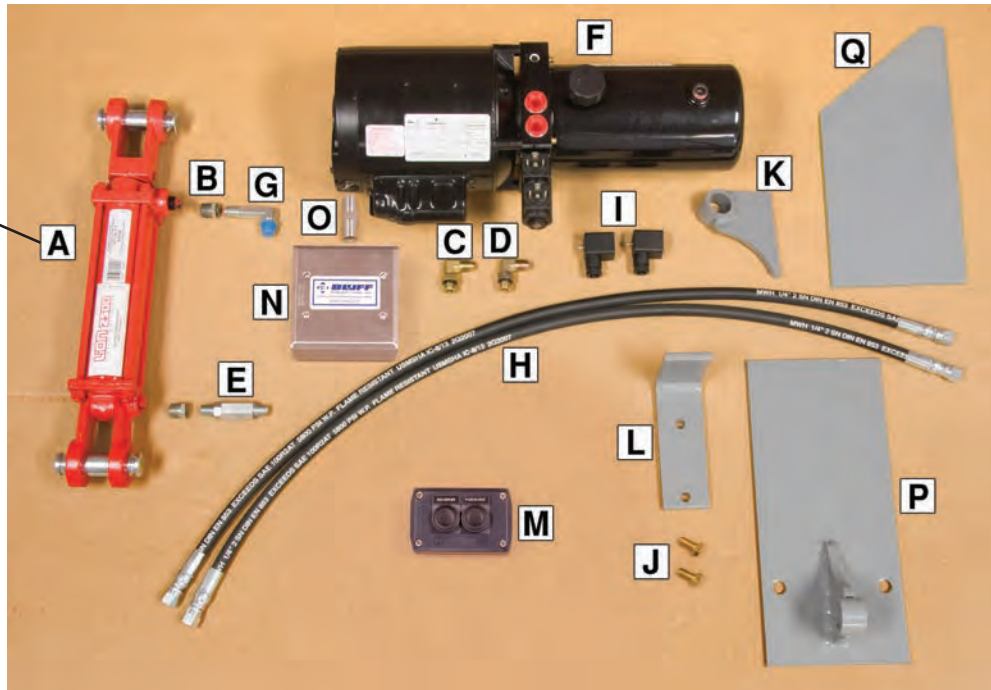

ITEM	QTY	PART #	DESCRIPTION
A	1	MHYDCYLINDER	6" STROKE, TIE ROD HYD.CYLINDER.
B	2	Y3414B	FITTING REDUCER
C	1	MADAPTER90	90 DEG. ELBOW SHORT
D	1	MADAPTER90XL	90 DEG. ELBOW LONG
E	1	YFCV	FLOW CONTROL VALVE
F	1	MPOWERUNIT	AC HYD-PWR UNIT
G	1	Y90ML	90 DEG. ELBOW
H	1	Y30HH	30" HYDRAULIC HOSES
I	2	**	SOLENOID CONNECTORS
J	2	F3834H	PUMP MOUNT BOLTS
K	1	EPHUBKT	EP-HYD. UPPER BRACKET
L	1	EPPMBKT	EP PUMP MOUNT BRACKET
M	1	MPUSHBUTTON	WALL MOUNTED PUSH BUTTON
N	1	M442GANGBOX	ELECT. JUNCTION BOX
O	1	M123RIGIDNIPPLE	3" PIPE FITTING
P	1	EPHLBKT	EP-HYD. LOWER BRACKET
Q	1	EPHDS	EP-HYD. DECK STOP

** Included MPOWER UNIT

Complete Hydraulic Set-Up Installation Instructions For Factory Issued Hydraulic Unit



NOTE: FOR LO-DOCK APPLICATIONS CALL YOUR LOCAL BLUFF DEALER AT 800-433-2212.

1. Prior to mounting, refer to EZ-Pull dock parameters and mounting instructions for Mechanical Edge-of-Dock Levelers or Lo-Dock Levelers for mounting the leveler unit.
2. Lift the lip of the EZ-Pull leveler to expose the brackets as shown below.
3. Anchor the mount plate as shown below.
4. Weld EPHLBKT lower bracket in-line with the EPHUBKT upper bracket.

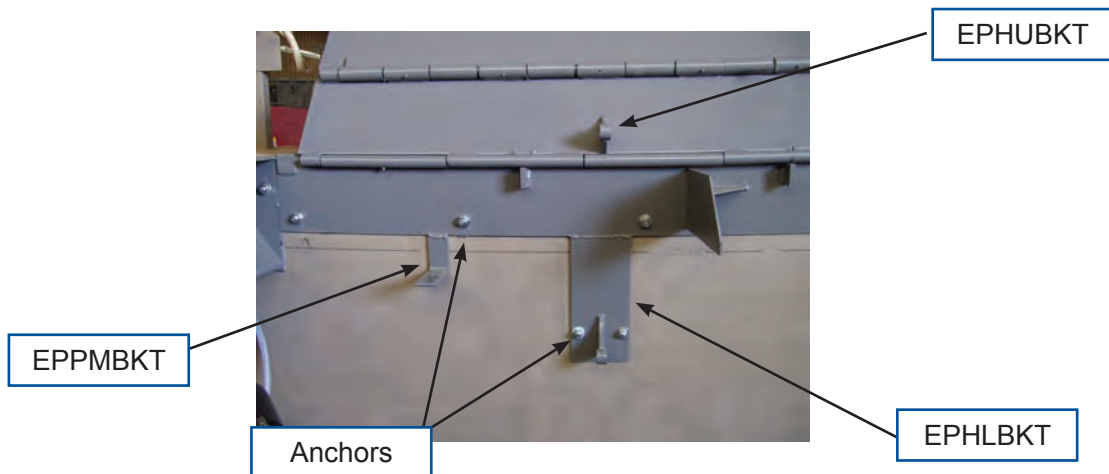

5. Mount the MPOWERUNIT on the pump mount bracket EPPMBKT.

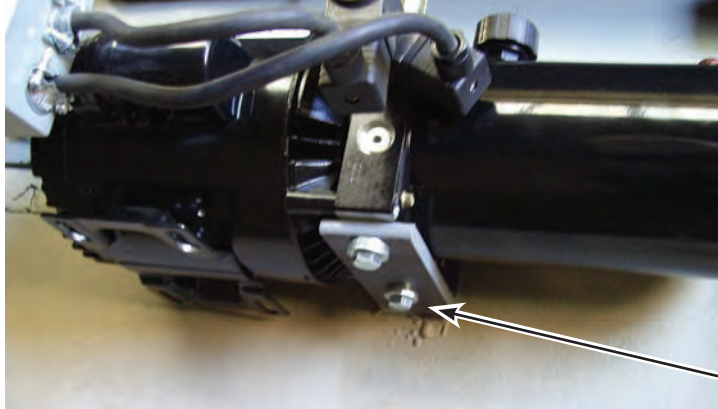

3/8"-16 x 3/4" Bolts

6. Mount the MHYDCYLINDER onto the lower bracket EPHLBKT.

7. Install and connect hoses as shown below. When connecting the hydraulic hoses to the fitting use Teflon tape.

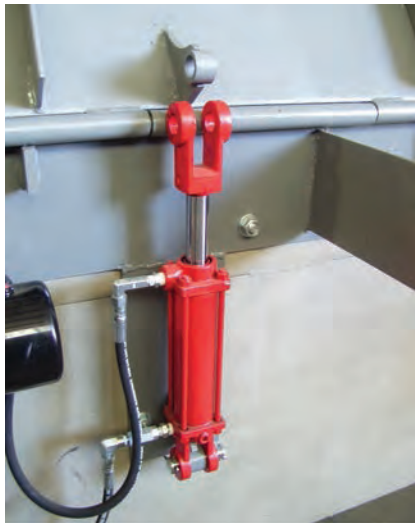

8. Mount the switch (MPUSHBUTTON) on the interior of the building wall.



CAUTION: ONLY QUALIFIED PERSONNEL SHOULD ATTEMPT TO PERFORM THE FOLLOWING WIRING INSTRUCTIONS.

Push button unit

NOTE: Customer to furnish wire for push button to motor and push button to plug. 115 VAC plug required.

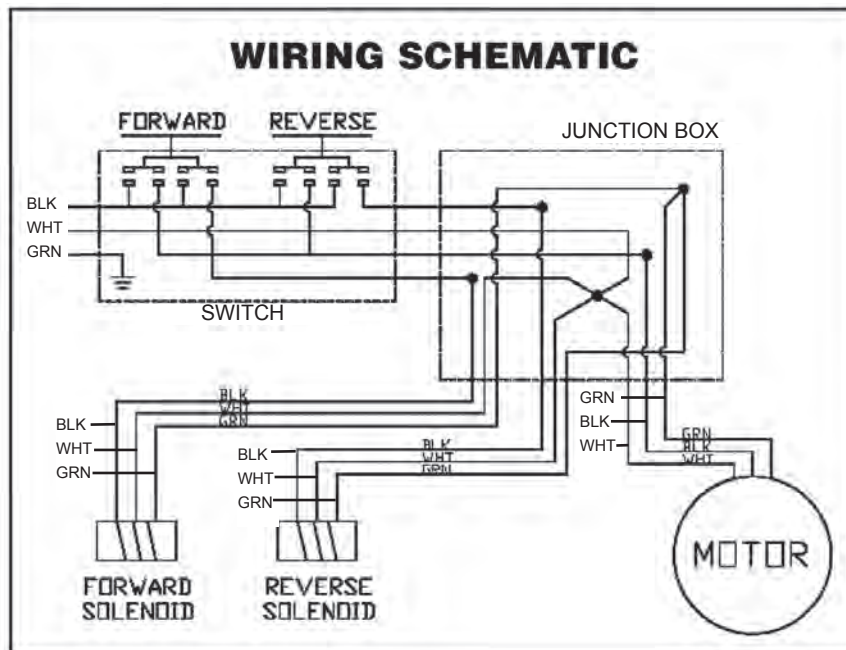
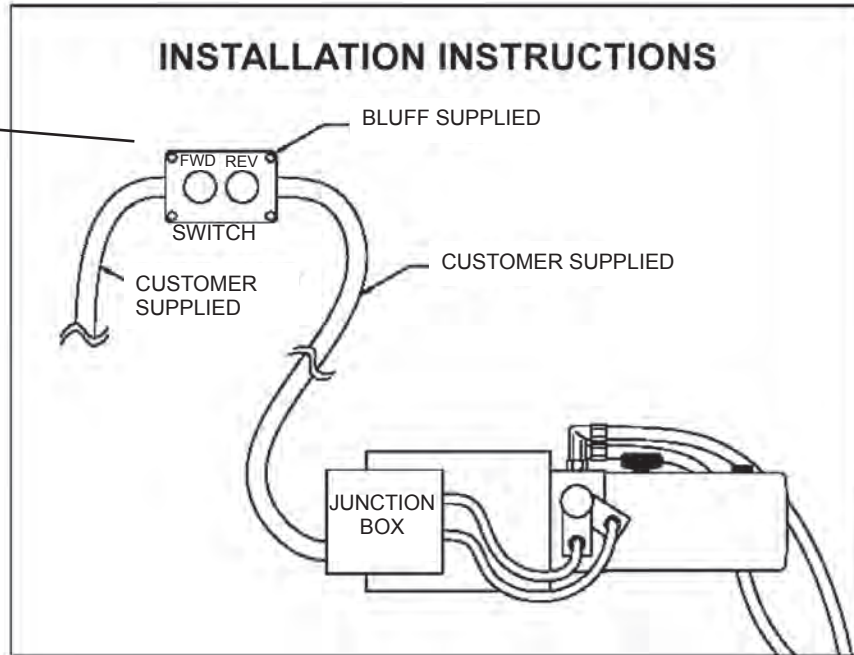

Wiring Instructions:

NOTE: All wiring should be done in accordance with local electric codes.

The unit requires 120 Volt, Single Phase current.

The photo below shows how to hook the incoming power and the connection to Junction Box on the unit. The Push Button Switch Box and the Junction Box have been pre-wired and all that is needed is the incoming power, and the connection from the Push Button and the Junction Box. The customer supplies the incoming current wires and connection from the Push Button and the Main Junction Box.

Use #14 stranded wire, with conduit according to your local electric code.

Be sure and observe all local Electric Codes.

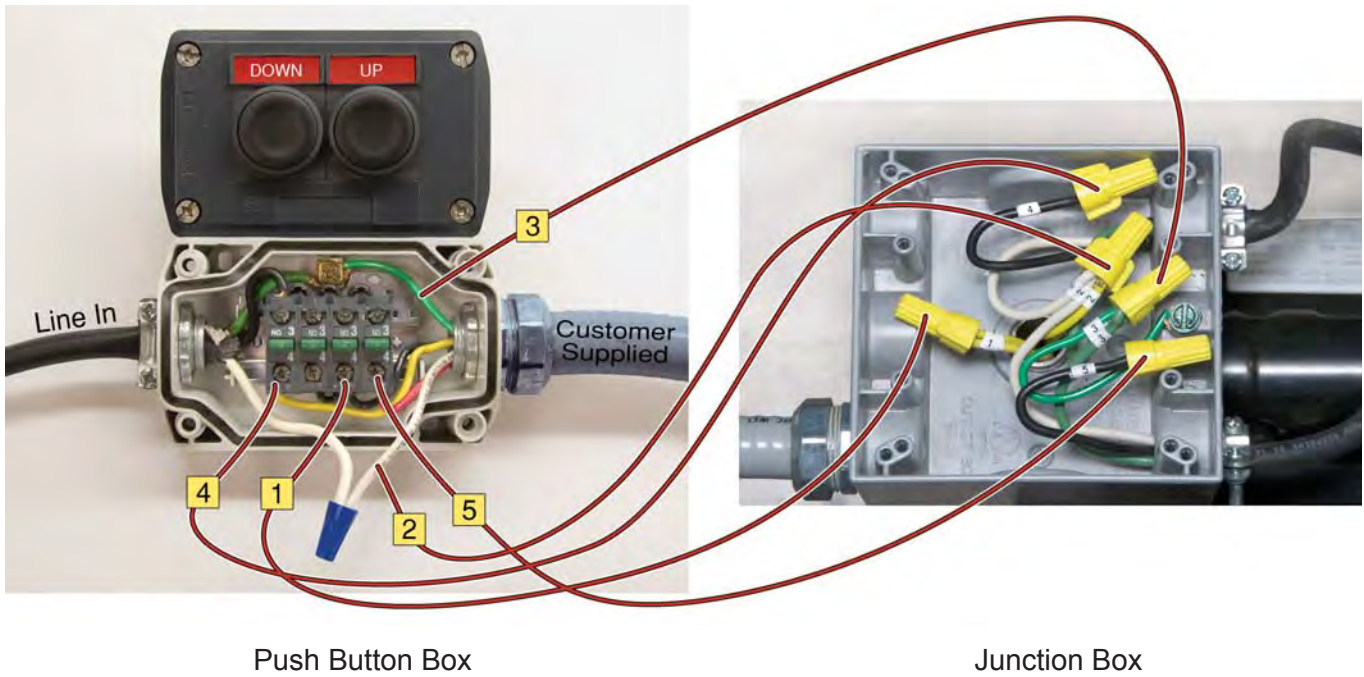

The direction of travel can be switched by swapping leads 4 and 5, or by swapping the connectors on the valve body.

IMPORTANT

9. Items ship without hydraulic fluid. FILL THE RESERVOIR WITH COMMON GRADE HYDRAULIC FLUID. (Common grade fluid is ISO 46). For areas of sub-freezing temperatures, a lighter grade (ISO 32) may be used.
10. Power the MPOWERUNIT and jog the motor to test wiring.
11. Jog motor to extend the MHYDCYLINDER such to attach to the upper bracket EPHUBKT utilizing the provided pin and keepers.



12. Carefully lower the lip to its rest position.
13. Press the forward and reverse button to complete a full cycle.
14. Refer to the trouble-shooting guide if unit does not function properly.

Operating Instructions

Hydraulic Edge of Dock Levelers

Step 1: With truck back into position and trailer door open, depress the reverse button until the latch falls into position. See illustration below.



Step 2: Once the latch falls into position, release the reverse button and depress the forward push button.

Step 3: The front lip will begin to extend forward, continue to hold the forward button until the front lip rests on the truck floor or the latch kicks off and the front lip lowers onto the truck floor.

Step 4: To return the hydraulic leveler to its resting position, for proper storage, depress the reverse button until the front lip clears the truck bed and raises into a vertical position.

Step 5: The hydraulic fluid will return to the tank. The deck section will slowly lower to its resting position parallel to the dock face.

NOTE: When Leveler is not in use, keep in lowered, stored position.

Troubleshooting Guide

(For all types of edge of dock units)

SYMPTOM:**POSSIBLE PROBLEM:**

 Leveler will not pivot

No grease in hinge and tube joints.

No hydraulic fluid in tank.

Missing or broken component.

 Check for obstruction preventing proper operation.

Leveler will not extend forward

Latch installed incorrectly. (Reverse)

Latch did not engage.

Leveler installed below the dock level and the unit not allowed to pivot back enough to for the latch to engage.

No hydraulic fluid in unit, leak in hose.

 Broken or missing component.

Lip not returning to stored position

Latch not disengaging.

Insufficient grease in hinges.

 Check for debris or obstructions.

Leveler not moving (motor running)

Check fluid level.

Pushing wrong button.

Faulty hose, damaged valve stem.

 Wiring wrong, damaged components.

Leveler will not move (motor not running)

Check wiring, voltage, etc.

Motor damaged.

Bad push button switch.

 Power Outage. Unit cannot be worked manually.

Complete Hydraulic Set-Up Installation Instructions For In-Field Retro-Fit of Existing Leveler Unit

Retro-Fit



NOTE: The leveler selected for the retro-fit hydraulic package must be in acceptable working condition.

1. Lift the front lip of the EZ-Pull leveler to expose the brackets as shown below.
2. Remove the spring assembly leaving the deck stop and gusset.

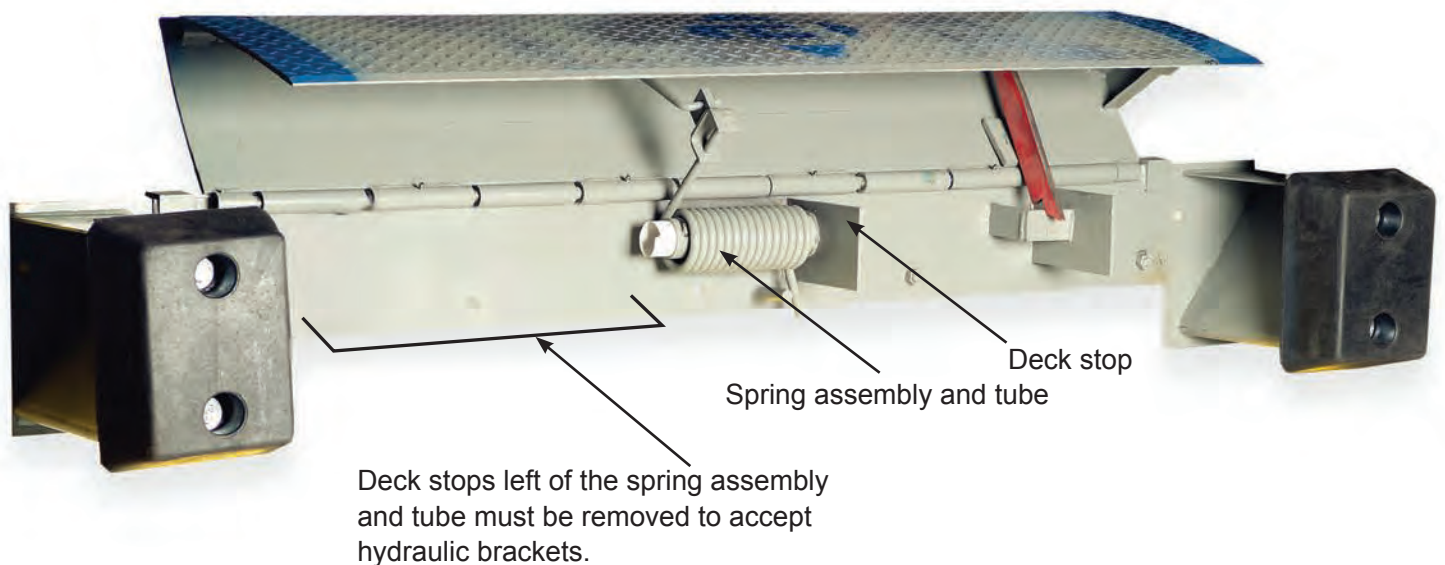

Complete Hydraulic Set-Up Installation Instructions For In-Field Retro-Fit of Existing Leveler Unit (continued)

3. Clean the surface and weld the brackets as shown below.

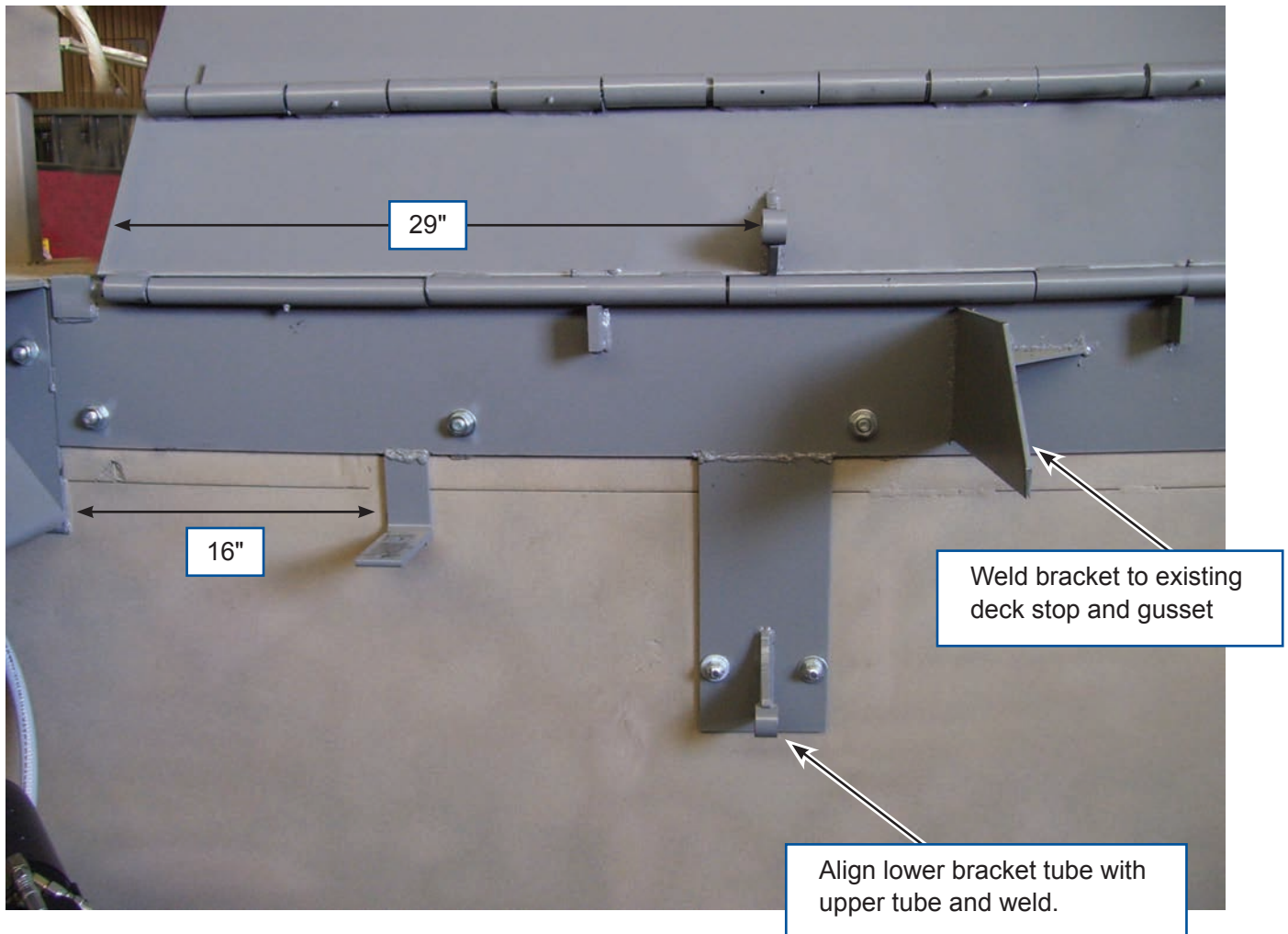

4. Anchor the lower bracket to side of dock.

5. To complete the retro-fit follow steps 5 thru 14 of the complete EPHYDRAULIC option.



Bluff Warranty

Bluff Manufacturing warrants their products to be free from defects in material and workmanship for a period of one year from shipping date to original purchaser. Yard ramp pumps and EOD hydraulic power units are warranted for 90 days from shipping date to original purchaser. Warranty eligibility requires all products are used and serviced in accordance with the company's recommendations, product selection guides, product manuals and installation instructions.

Bluff Manufacturing's obligation under this warranty shall be limited to the repair, by Bluff Manufacturing or a Bluff Manufacturing authorized technician, or exchange of any part of parts which may prove defective under normal service within the time limitations set forth above, and which our examination shall disclose to our satisfaction to be defective. Bluff Manufacturing requires the purchaser to send date stamped photographs for initial review of warranty claim products.

This limited warranty does not cover any defects, malfunction or failure caused by or resulting from improper or unauthorized service, maintenance, installation repair or use not in conformance or accordance with Bluff Manufacturing's recommendations, product selection guides, product manuals or installation instructions and the intended use and capacities or specifications or from abuse, neglect, accident, weather related issues or any other cause beyond the control of Bluff Manufacturing. This limited warranty is made only to the original purchaser, which shall be deemed to mean that person or organization to which the product is originally shipped or installed.

Bluff Manufacturing does not approve nor authorize any other person or entity to obligate Bluff Manufacturing to any other liability not described herein concerning the sale of its products.

Bluff Manufacturing shall not be liable for any incidental or consequential damages. And liability hereunder is expressly limited to repair or replacement of any part or parts which may prove defective within the time prescribed hereon.

This warranty is expressly in lieu of all other warranties, expressed or implied, including the warranties of merchantability and fitness for a particular purpose and all other obligations or liabilities on our part.

Bluff Returned Goods Authorization (RGA)

Before returning any merchandise for any reason whatsoever, it is necessary to contact Bluff Manufacturing for approval. All requests must be submitted with a date stamped photograph of item to be returned. If approval is given, an RGA number will be given by Bluff Manufacturing. This RGA number must appear on all documents involving the returned goods.

Freight charges on all RGA's must be PREPAID on returns but not warranties.

RGA numbers will not be issued after ninety (90) days from date of shipment, except for warranty items, by Bluff Manufacturing or its designated representative.

A restocking charge of 25% will be made on all merchandise except as allowed under warranty claims.

Returns will not be allowed on any custom, special or worksheet required items and products in non-resalable condition.