



VESTIL MANUFACTURING CORP.

2999 North Wayne Street, P.O. Box 507, Angola, IN 46703
 Telephone: (260) 665-7586 Toll Free (800) 348-0868
 Fax: (260) 665-1339 www.vestilmfg.com e-mail: sales@vestil.com

WP AND SP-SERIES WORK PLATFORMS INSTRUCTION MANUAL

KEEP THIS MANUAL FOR FUTURE REFERENCE OF OPERATORS. CHECK VESTIL.COM FOR UPDATES TO THE MANUAL. DO NOT USE UNLESS EACH LABEL IS AFFIXED TO THE PLATFORM (AS SHOWN IN FIG. 12 ON P. 14), UNDAMAGED AND READABLE.



WP-3737-FD

CAPACITY: 600LB (273KG)



WP-SERIES

1,000LB (455KG)



SP-SERIES

1,000LB (455KG)

Receiving instructions:

After delivery, inspect the product closely to determine whether it sustained damage during transport. **If damage is discovered, record a complete description of the damage on the bill of lading.** If the product is undamaged, discard the packaging.

NOTES:

Compliance with laws, regulations, codes, and non-voluntary standards enforced in the location where the product is used is exclusively the responsibility of the owner/end-user.

Vestil is not responsible for *any* consequential damages sustained as a result of failing to exercise sound judgment while assembling, installing, using or maintaining this product.

Table of Contents

| | |
|---|------------|
| Product Introduction..... | 2 – 3 |
| Safety Principles..... | 4 |
| Safety Guidelines..... | 4 – 5 |
| Inspections..... | 5 |
| Loading the Platform..... | 8 |
| Use Instructions..... | 9 |
| Setup/Fold-Down Instructions | |
| (WP-3737-FD)..... | 10 - 11 |
| Mounting Casters to WP-Series Platforms.. | 12 |
| Emergency Stop Switch Installation..... | 13 |
| Labeling Diagrams..... | 11, 14, 15 |
| Limited Warranty..... | 16 |

Table of Figures

| | |
|---|----|
| Fig. 1 “WP-series Diagram & Parts List”..... | 6 |
| Fig. 2 “SP-175 series Diagram & Parts List”..... | 6 |
| Fig. 3 “Center of Gravity Diagram”..... | 7 |
| Fig. 4 “Mast Guard Hinge”..... | 7 |
| Fig. 5A & 5B Tine Lock Operation..... | 8 |
| Fig. 6 “Proper attachment of nylon safety strap”..... | 8 |
| Fig. 7 “Caster Insertion”..... | 12 |
| Fig. 8 “FTJB & WPJB mounting diagram”..... | 13 |
| Fig. 9 “Electrical system diagram”..... | 13 |
| Fig. 10 “Mounting WPJB”..... | 13 |
| Fig. 11 “[WPJB] Fastener order”..... | 13 |

Product specifications:

Thank you for purchasing a fork-mountable work platform made by Vestil Manufacturing Corporation. Our platforms are durable, high-quality products that combine safety-conscious design features and rigorous engineering. Anyone who might use or maintain this product should be familiar with the instructions provided in this manual.

Dimensions and other product specifications corresponding to each model appear in the following tables:

| Model | Platform dimensions Width x Length in inches (cm) | Distance between the centers of fork pockets | Height of (expanded metal) mast guard | Net weight in pounds (~kg) |
|--|---|---|--|-------------------------------|
| WP-3636 | 36" x 36" (91 x 91)cm | 16" (41 cm) | 60" (152 cm) | 200 lb. (91 kg) |
| WP-3648 | 36" x 48" (91 x 122)cm | 16" (41 cm) | 60" (152 cm) | 230 lb. (105 kg) |
| WP-4848 | 48" x 48" (122 x 122)cm | 24" (61 cm) | 60" (152 cm) | 275 lb. (125 kg) |
| WP-4848-FF | 48" x 48" (122 x 122)cm | 24" (61 cm) | 60" (152 cm) | 295 lb. (134 kg) |
| WP3636-84B | 36" x 36" (91 x 91)cm | 16" (41 cm) | 84" (213 cm) | 246 lb. (112 kg) |
| WP-3648-84B | 36" x 48" (91 x 122)cm | 16" (41 cm) | 84" (213 cm) | 259 lb. (118 kg) |
| WP-4848-84B | 48" x 48" (122 x 122)cm | 24" (61 cm) | 84" (213 cm) | 300 lb. (136 kg) |
| WP-4848-FF-84B | 48" x 48" (122 x 122)cm | 24" (61 cm) | 84" (213 cm) | 316 lb. (144 kg) |
| WP-3636-DD | 36" x 36" (91 x 91)cm | 16" (41 cm) | 60" (152 cm) | 234 lb. (106 kg) |
| WP-3648-DD | 36" x 48" (91 x 122)cm | 16" (41 cm) | 60" (152 cm) | 247 lb. (112 kg) |
| WP-4848-DD | 48" x 48" (122 x 122)cm | 24" (61 cm) | 60" (152 cm) | 288 lb. (131 kg) |
| WP-4848-DD-FF | 48" x 48" (122 x 122)cm | 24" (61 cm) | 60" (152 cm) | 304 lb. (138 kg) |
| WP3636-84B-DD | 36" x 36" (91 x 91)cm | 16" (41 cm) | 84" (213 cm) | 246 lb. (112 kg) |
| WP-3648-84B-DD | 36" x 48" (91 x 122)cm | 16" (41 cm) | 84" (213 cm) | 259 lb. (118 kg) |
| WP-4848-84B-DD | 48" x 48" (122 x 122)cm | 24" (61 cm) | 84" (213 cm) | 300 lb. (136 kg) |
| WP-4848-FF-84B-DD | 48" x 48" (122 x 122)cm | 24" (61 cm) | 84" (213 cm) | 316 lb. (144 kg) |
| *WP-3737-FD (FOLD-DOWN MODEL) | 37" x 37" (94 x 94)cm | 26" (66 cm) | 60" (152 cm) | 175 lb. (80 kg) |
| "Stock-picker" (SP) series work platforms | | | | |
| SP-175 | 30" x 20" (76 x 51)cm | 22 ¹ / ₄ " (57 cm) | 60" (152 cm) | 185" (84 kg) |
| SP-175-84B | 30" x 20" (76 x 51)cm | 22 ¹ / ₄ " (57 cm) | 84" (213 cm) | 190" (86 kg) |

NOTE: To calculate the weight of a "fully loaded platform," select the specific model you own/use, find the net weight of your model in the table above, and then add: 1) 1,000 pounds (455 kg) for all WP-series models except the fold-down WD-3737-FD; 2) 1,000 pounds (455 kg) for SP model platforms; or 3) 600 pounds (273 kg) for WP-3737-FD platforms.

| Work platform safety options | | |
|-------------------------------------|---|--------------------|
| Model | Description | Weight |
| WP-CA | 4" x 1 ¹ / ₄ " polyurethane-on-polyurethane casters: 2 swivel & 2 rigid | 20 lb. (9.1 kg) |
| WP-SB | Emergency stop button kit | 7 lb. (3.2 kg) |
| WP-SB-FTJB | Emergency stop junction box – Fork truck | 8 lb. (3.6 kg) |
| WP-SB-WPJB | Emergency stop junction box – Work platform | 5 lb. (2.3 kg) |
| WP-TC | Fluorescent tube caddy | 15 lb. (6.8 kg) |
| WP-P-TC | Fluorescent tube caddy (plastic) | |
| WP-TT36 | 36" tool tray | 13 lb. (5.9 kg) |
| WP-TT48 | 48" tool tray | 22 lb. (10 kg) |
| WP-AFR | Automatically deploying ramp | 222 lb. (100.9 kg) |
| WP-WS | Caution sign with necessary mounting hardware | 3 lb. (1.4 kg) |
| WP-DL | Double chain door lock | 2 lb. (0.9 kg) |

| Recommended Lanyard and Safety Harness Options (see sizing chart below) | | | |
|--|---------------------------------|-----------------------|-----------------|
| Item designation | Description | Lanyard length | Weight |
| WP-LH-S | Small harness | 6ft. (~1.83m) | 10 lb. (4.5 kg) |
| WP-LH-M | Medium harness | 6ft. (~1.83m) | 10 lb. (4.5 kg) |
| WP-LH-L | Large harness | 6ft. (~1.83m) | 10 lb. (4.5 kg) |
| WP-LH-XL | Extra large harness | 6ft. (~1.83m) | 10 lb. (4.5 kg) |
| WP-LH-XXL | Extra-extra large harness | 6ft. (~1.83m) | 10 lb. (4.5 kg) |
| WP-LH-XXXL | Extra-extra-extra large harness | 6ft. (~1.83m) | 10 lb. (4.5 kg) |

| Height of User | Waist Size of User | | | | | |
|--|---------------------------|----------------|----------------|----------------|----------------|----------------|
| | 34"-36" | 38"-40" | 42"-44" | 46"-48" | 50"-54" | 56"-60" |
| 5ft 4in – 5ft 7in (163 – 170)cm | Small | Small | Medium | Large | X-Large | XX-Large |
| 5ft 8in – 5ft 11in (173 – 180)cm | Small | Medium | Large | X-Large | XX-Large | XXX-Large |
| 6ft – 6ft 3in (183 – 191)cm | Medium | Medium | Large | X-Large | XX-Large | XXX-Large |
| 6ft 3in and Taller 191cm and taller | Large | Large | X-Large | X-Large | XX-Large | XXX-Large |

| Platform Model | Maximum Rated Load |
|----------------------------|---------------------------|
| WP-series except fold-down | 1,000 lb. |
| SP-series | 1,000 lb. |
| Fold-down WP-3737-FD | 600 lb. |

Employers are responsible for instructing employees to use the product properly (see OSHA standard 1910.178 and 1993 letter of interpretation accessible at:





http://www.osha.gov/pls/oshaweb/owadisp.show_document?p_table=INTERPRETATIONS&p_id=21322.

EVERY person who might assemble, use, or perform maintenance on this work platform must read and understand every instruction BEFOREHAND. Users should have access to the manual at all times and should review the directions whenever necessary.

Signal words:

This manual uses SIGNAL WORDS to indicate the likelihood of personal injuries, as well as the probable seriousness of those injuries, if the product is misused in the ways described. Other signal words call attention to uses of the product likely cause property damage.

The signal words used appear below along with the meaning of each word:

| | |
|--|--|
|  | Identifies a hazardous situation which, if not avoided, <u>WILL</u> result in DEATH or SERIOUS INJURY. Use of this signal word is limited to the most extreme situations. |
|  | Identifies a hazardous situation which, if not avoided, <u>COULD</u> result in DEATH or SERIOUS INJURY. |
|  | Indicates a hazardous situation which, if not avoided, <u>COULD</u> result in MINOR or MODERATE injury. |
|  | Identifies practices likely to result in product/property damage, such as operation that might damage the platform. |

Safe use recommendations:

Failure to read and understand the instructions included in this manual before using or servicing the work platform constitutes misuse of the product. Study the entire manual before you use the product for the first time and before each subsequent use. Read the manual to refresh your understanding of the safe use, inspection and maintenance procedures explained on p. 5. If questions remain about the product after you finish reading the manual, contact Vestil for answers. DO NOT attempt to resolve any problems with the work platform unless you are authorized to do so and are certain that it will be safe to use afterwards.

 Electrocutation might result if the work platform contacts electrified wires. Reduce the likelihood that platform occupants or bystanders might be electrocuted by applying **common sense**:

- DO NOT *contact* electrified wires with any part of the platform;
- DO NOT use the platform in an area where contact with electrified wires is likely;
- DO NOT use the work platform in *close proximity* to electrified wires or other sources of electricity.

 Material handling is dangerous. Improper or careless operation might result in serious personal injuries sustained by the boom operator(s) and bystanders. Your use of the platform must always conform to OSHA "Powered industrial trucks" regulations (29 CFR 1910.178 accessible at <http://ecfr.gpoaccess.gov/cgi/t/text/text-idx?c=ecfr&sid=96a878227f273aa6ec3cea186e1c142b&rgn=div8&view=text&node=29:5.1.1.1.8.14.37.3&idno=29>). In addition to requirements by law, work platform users should conform to the following:

- Contact the manufacturer of your lift truck to verify that the truck is capable of safely handling the fully loaded platform (see "NOTE" on p. 2). The width of your platform must be equal to or less than the width of your fork truck plus 10 inches (250mm).
- DO NOT exceed the maximum occupancy ratings for each model:
 - WP-series = 2;
 - SP-175 = 1;
 - WP-3737-FD = 2.
- ONLY use the work platform as a means for lifting people and necessary tools and equipment.
- DO NOT use a structurally compromised work platform. Examples of structural damage includes: broken railings, broken fork pockets, and holes produced by rust or corrosion in the platform floor or mast guard. Inspect the platform before each use according to the inspection instructions on p. 5. DO NOT use the platform unless it passes *every* part of the inspection.
- DO NOT use a damaged platform. Inspect the unit before each use according to the inspection instructions on p. 5. DO NOT use the platform unless it passes *every* element of the inspection.
- Platform occupants and fork truck operators must wear hard hats whenever this platform is used.
- DO NOT use the platform if the safety chain/strap is damaged or missing; DO NOT lift the platform until it is securely connected to the carriage of the fork truck with the safety strap. **NOTE:** The safety chain/strap is the primary safety mechanism, and must be used each time the work platform is used! To use the safety chain/strap properly, attach the device to the fork truck carriage as instructed in Step 2 on p. 9. Each work platform also includes a secondary safety feature called a tine lock that secures the platform to a tine of your fork truck. However, the lock might not fit over the heel of the tine of your fork truck. If this is the case, do not modify the tine lock; simply do not use it.
- DO NOT attempt to support a load that weighs more than the platform's maximum rated load. The net weight, i.e. the sum of the weight of all occupants and everything else supported by the platform, cannot exceed the maximum rated load of the platform.
- DO NOT stand beneath or travel under the platform while it is elevated.
- DO NOT use the gate(s), chains, mast guard, guardrails, etc. as a step.

⚠WARNING (Continued from p. 4)

- Platform occupants must ALWAYS use personal fall protection equipment securely attached to the platform at an anchorage point (see “Operation and use” diagrams on p. 9) as long as the platform is elevated. Only disconnect from an anchorage point when the platform rests securely on the ground.
- **DO NOT use UNLESS each label shown in Fig. 12 on p. 14 is affixed to the platform, undamaged and readable.**
- Occupant safety depends on maintaining a work platform in level, horizontal position. Only use work platforms on improved surfaces (asphalt or concrete) that are even and level.
- DO NOT mount a work platform on a telehandler, aka boom lift, or rough terrain forklift, even if the handler will be used on level concrete or asphalt.

Inspections:

Before each use inspect the listed components:

1. Tine lock(s): confirm normal function. Model specific tine lock information appears on p. 8.
2. Snap hook attached to the free end of the nylon safety strap: confirm that the spring latch automatically closes securely against the hook as shown in the diagram to the right. If the hook, nylon strap, or latch is damaged, do not use the platform until a complete, new safety strap is obtained and attached to the platform D-link (see p. 9).
3. Gate latch(es):
 - WP-3737-FD: confirm that each gate latch functions normally (see “Step 4” on p. 11);
 - SP-175 series: confirm chains, D-links, snap rings and D-links are undamaged;
 - WP-series: gate(s) are spring-actuated and should automatically close when released. If a gate(s) does not automatically close, replace the spring before resuming use of the platform.
4. Handrails: check the rails, rail welds, and points of attachment to the platform for bending, warping and cracking.
5. Lanyard attachment points: check the anchorage weldment (see diagrams on p. 9) and points of attachment to the mast guard for bending, warping, or cracking.
6. Casters (if equipped with WP-CA kit): check the casters to confirm that each one is properly seated within the corner handrail posts (see p. 12).
7. Product labels: all labels should be readable and located as shown in the diagram on p. 14. If a label(s) is unreadable or missing, contact Vestil to order a replacement.

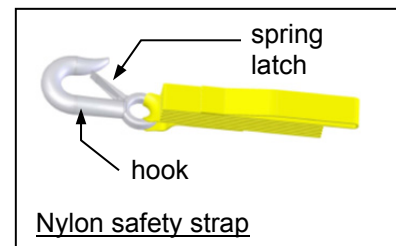

At least 1 time per month, inspect:

1. Fasteners (hardware):
 - Mast guard hinge - bolts, nuts, washers;
 - Tine lock - pins, cotter pins, spring pins, and tine brackets (see p. 8);
 - Gates – chains, latches, hinges, pins, springs.
2. Casters: look for excessive wear, bending or cracking; if present, do not use the casters to move the platform until the damaged caster(s) is replaced.
3. Fork pockets: confirm that each pocket is structurally sound, not corroded or rusted. Do not use the platform if the fork pockets are structurally compromised or excessively rusted or corroded.
4. Welds: confirm that all welds are intact.
5. Obvious damage to, or structural deformation of, handrails, gate(s), or the platform itself.
6. Overall condition of platform: the structure should be clean, square and rigid, and free of rust and corrosion. Remove dirt and debris. Do not use the platform if the base is excessively rusted or corroded.

FIG. 1: WP-series Diagram & Parts List

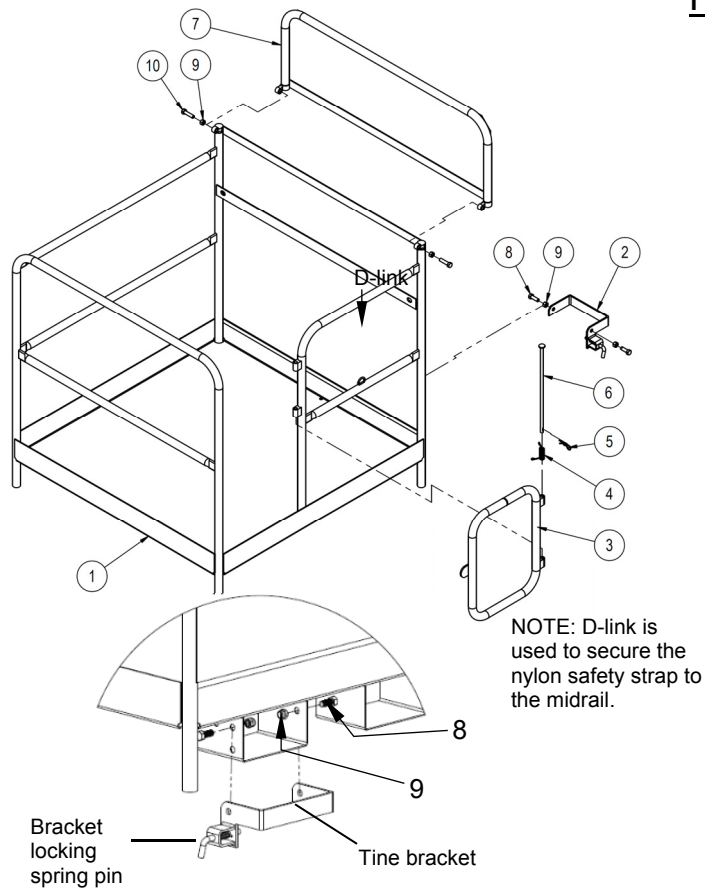

| Item No. | Description | Part No. | Quantity |
|------------------------|---|------------|----------|
| 1 | Weldment, frame: | | |
| | WP-3636 | 14-514-118 | 1 |
| | WP-3648 | 14-514-119 | 1 |
| | WP-4848 | 14-514-120 | 1 |
| | WP-3636-DD | 14-514-095 | 1 |
| | WP-3648-DD | 14-514-096 | 1 |
| WP-4848-DD | 14-514-097 | 1 | |
| 2 | WP tine lock assembly | 14-537-007 | 1 |
| 3 | Hinged gate weldment | 14-514-093 | 1 |
| 4 | 9/16" x 2-1/4" spring | 14-146-002 | 1 |
| 5 | #11 hitch pin | 45286 | 1 |
| 6 | Pin, axle | 13-112-001 | 1 |
| 7 | Upper mast guard weldment | | |
| | WP-3636 models: | | |
| | Standard mast guard | 14-514-125 | 1 |
| | 48in. (Cal-OSHA) upper mast guard | 14-514-128 | 1 |
| | WP-3648 models: | | |
| | Standard mast guard | 14-514-125 | 1 |
| 48in. (Cal-OSHA) guard | 14-514-128 | 1 | |
| WP-4848 models: | | | |
| | Standard mast guard | 14-514-126 | 1 |
| 48in. (Cal-OSHA) guard | 14-514-129 | 1 | |
| 8 | 1/2" - 13 x 1-1/2" HHCS #2 zinc-plated bolt | 11209 | 2 |
| 9 | 1/2" - 13 zinc-plated hex nut | 36110 | 2 |
| 10 | 1/2" - 13 x 2" HHCS zinc-plated bolt | 11211 | 2 |
| | Nylon safety strap | 08-145-028 | 1 |
| | Complete tine lock assembly | 14-537-007 | 1 |

FIG. 2: SP-175 series Diagram & Parts List

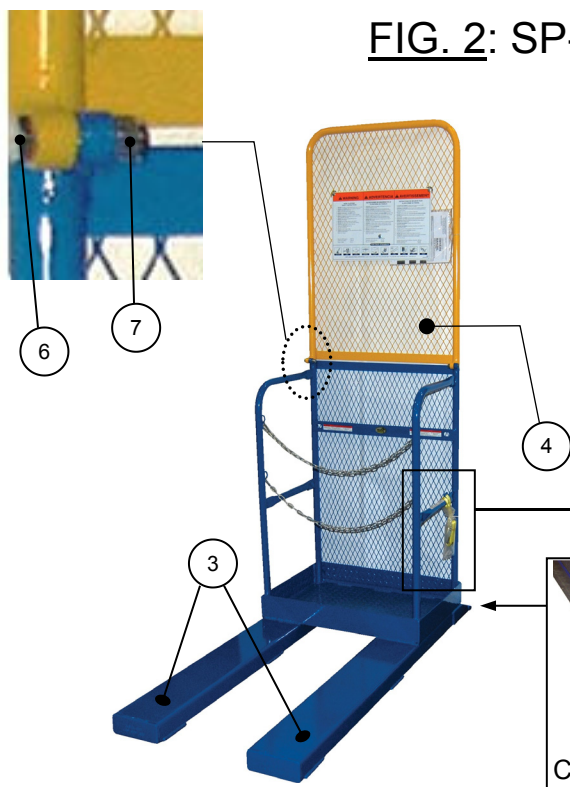

| Item no. | Part no. | Description | Quantity |
|----------|---------------|--|----------|
| 1 | 14-112-001 | 5/8in. x 9-1/2in. pin | 2 |
| 2 | 45286 | 1/8in. x 2-5/8in. (#11) hitch pin clip | 2 |
| 3 | 37-028-014 | Fork tubes | 2 |
| 4 | 14-514-127 | Upper mast guard (standard); | 1 |
| | 14-514-130 | Upper mast guard (Cal-OSHA) | |
| 5 | 1/4in. D-link | D-link | 4 |
| 6 | 10211 | 1/2 in. x 2in. hex head bolt | 2 |
| 7 | 36109 | 1/2 in. - 13 UNC hex head nut | 2 |

FIG. 3: Center of Gravity Diagram

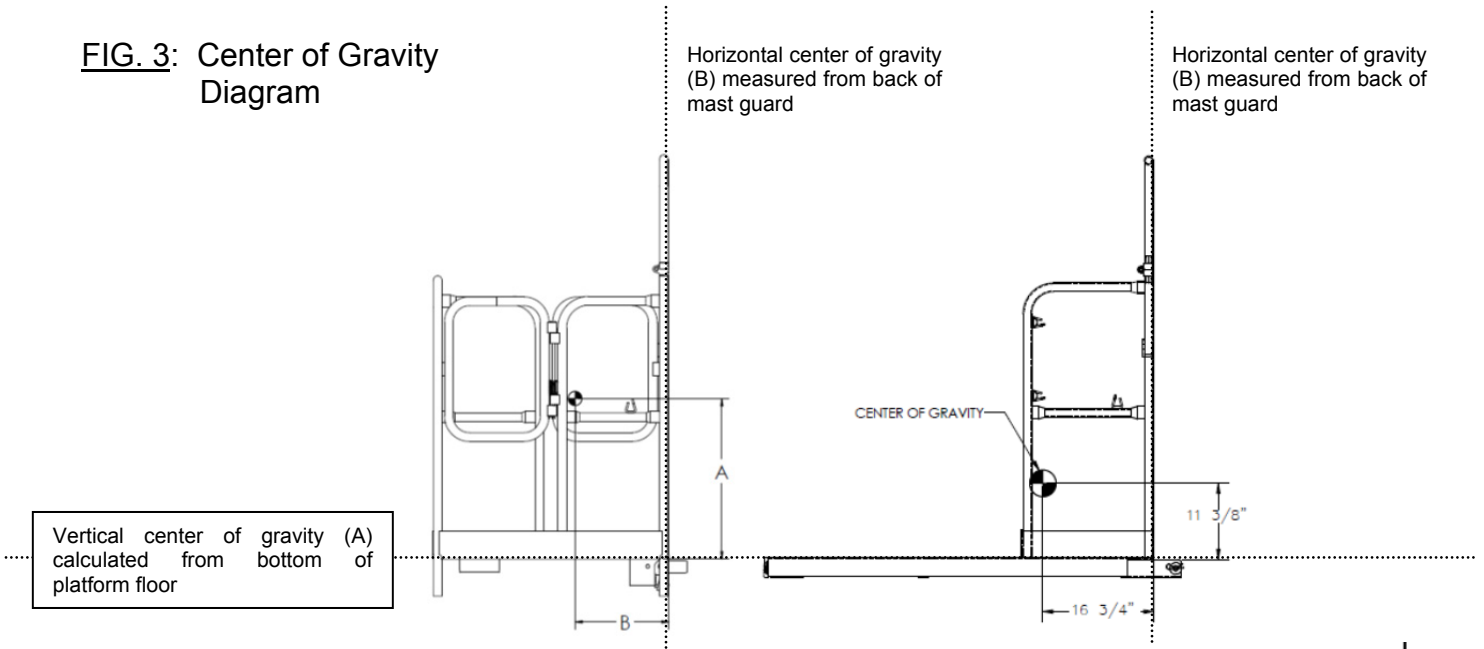

| Model | A: Vertical center of gravity in inches (~cm) | B: Horizontal center of gravity in inches (~cm) | Model | A: Vertical center of gravity in inches (~cm) | B: Horizontal center of gravity in inches (~cm) |
|-------------|---|---|----------------|---|---|
| WP-3636 | 15.9 (40.4cm) | 15.0 (38.1cm) | WP-3636-DD | 18.1 (46.0cm) | 13.7 (34.8cm) |
| WP-3648 | 15.4 (39.1cm) | 20.6 (52.3cm) | WP-3648-DD | 18.8 (47.8cm) | 17.0 (43.2cm) |
| WP-4848 | 14.5 (36.8cm) | 20.6 (52.3cm) | WP-4848-DD | 16.8 (42.7cm) | 18.5 (47.0cm) |
| WP-4848-FF | 14.5 (36.8cm) | 20.6 (52.3cm) | WP-4848-DD-FF | 16.8 (42.7cm) | 18.5 (47.0cm) |
| WP-3636-84B | 19.9 (50.5cm) | 14.1 (35.8cm) | WP-3636-84B-DD | 23.4 (59.4cm) | 12.5 (31.8cm) |
| WP-3648-84B | 18.9 (48.0cm) | 19.5 (49.3cm) | WP-3648-84B-DD | 21.9 (55.6cm) | 17.3 (43.9cm) |
| WP-4848-84B | 18.0 (45.7cm) | 19.5 (49.3cm) | WP-4848-84B-DD | 21.9 (55.6cm) | 17.0 (43.2cm) |
| SP-175 | 11.4 (29.0cm) | 16.8 (42.5cm) | WP-3737-FD | 16.5 (41.9cm) | 18.0 (45.7cm) |

Fig. 4: Mast Guard Hinge

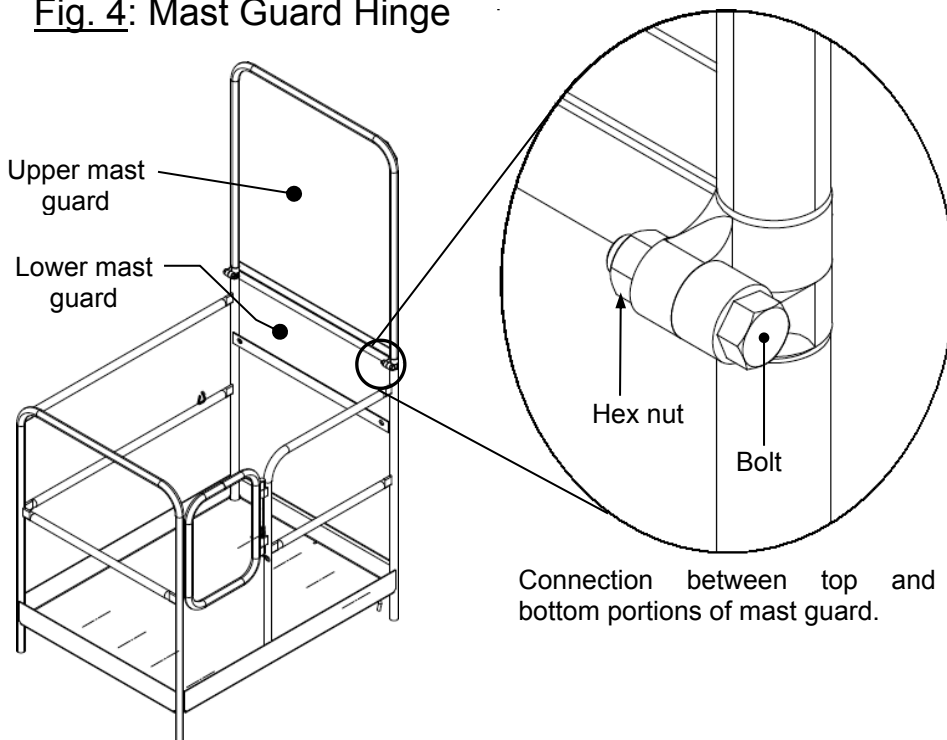

⚠ WARNING If the mast guard is improperly fastened, it cannot adequately protect platform occupants. Therefore, make sure that hinge fasteners (circled in the drawings) are tightened to **35ft·lb of torque. Retighten the connection to 35 ft·lb whenever:**

- The work platform is taken out of storage:
 - Raise the upper portion of the mast guard, and then
 - Tighten the bolts and nuts.
- If the mast guard is bumped or deflected from vertical.
 - Immediately lower the platform to the ground; then
 - Straighten the mast guard (return it to the vertical orientation) and retighten the bolts and nuts.

Loading the platform:

Each of our work platforms includes 2 means for securing the platform to a fork lift: 1) tine lock, AND 2) nylon safety strap.

Step 1: Attach the platform to a fork truck:

Drive the fork truck forward until the mast guard contacts the back of (vertical part) the tines. For all WP models, make sure that the tines extend through the front and rear fork pockets (see diagram below). Attach the platform to the fork truck's fork carriage with the safety strap, and capture the heel of the fork with the tine lock underneath the corner of the platform as shown in the drawings below.

NOTE: The safety strap is the primary safety mechanism, and must be used each time the work platform is used! To use the safety strap properly, attach the device to the fork truck carriage as instructed in Step 2 on p. 9. Each work platform also includes a secondary safety feature called a tine lock that secures the platform to a tine of your fork truck. However, the lock might not fit over the heel of the tine of your fork truck. If this is the case, do not modify the tine lock; simply do not use it.

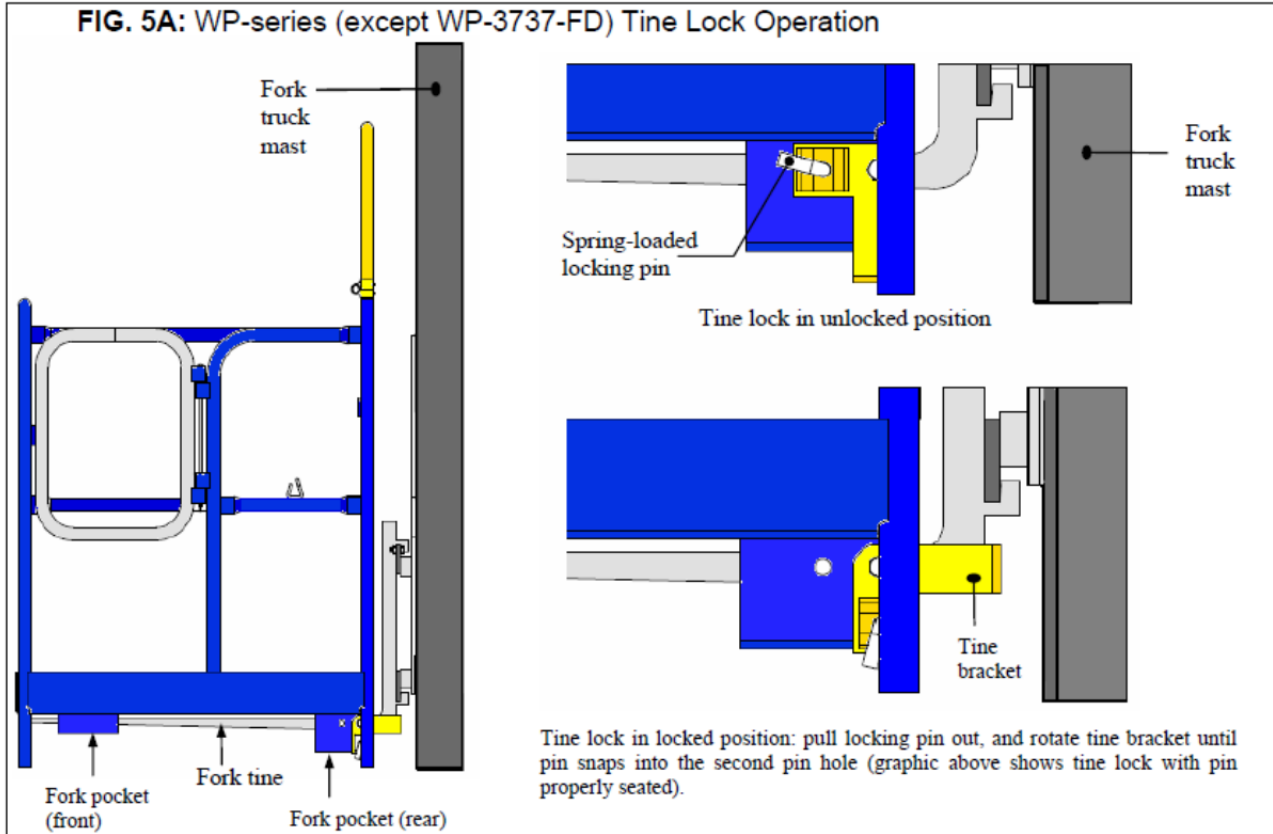
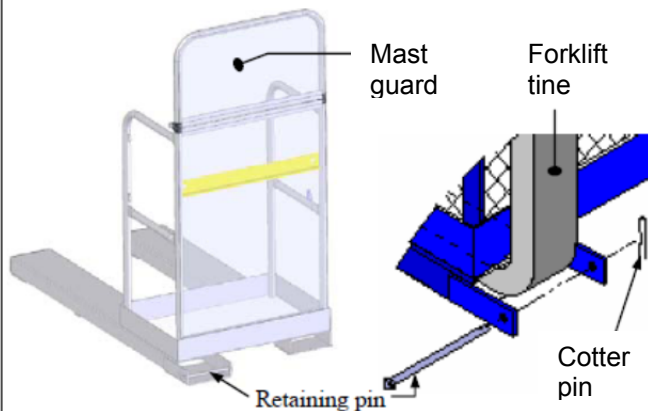

FIG. 5B SP-175 series & WP-3737-FD Tine Lock Operation: remove the retaining pin and cotter pin (SP-175's only) before driving the fork tines into the tine lock. WP-3737-FD's include tine locks on both fork pockets; SP-175 series platforms include a tine lock on only 1 (left) fork pocket. Drive the fork truck forward until the upright portions of the tines contact the mast guard; then insert the retaining pin and secure it with the cotter pin (SP-175's only).

SP-175 tine locks



WP-3737-FD tine locks



Step 2: Fasten the nylon safety strap to the fork carriage.

⚠️WARNING The nylon strap is an essential safety-enhancing feature. If the forks are accidentally tilted towards the ground, the strap will not prevent the platform from sliding off of the fork lift if it is improperly connected to either the platform or the fork lift. Use the strap to connect the work platform to the *carriage* of your fork truck. Wrap the strap around the carriage **with no slack** at one of the points indicated by dotted arrows in Fig. 6 (vertical midpoint of carriage).

As delivered to you (end-user) the safety strap is connected to the midrail. Each time the platform is engaged by a fork lift, the other end of the nylon strap must be connected to the fork carriage.

For all other WP-series platforms, the maximum rated load is 1,000 pounds (455kg). The load rating is posted on the Sign 080 fastened to the mast guard (see "Labeling diagram" on p. 11, 14, & 15). Only use the platform to lift one or two people along with necessary light tools and equipment. Maximum occupancy is two persons.

The maximum rated load of SP-series platforms is 1,000 pounds (455kg). These platforms are designed to lift only one person as well as a skid supported by the fork tubes. This arrangement allows the platform occupant to either remove stock from, or place stock onto, shelves. The weight of the skid loaded supported by the fork tubes must not produce a horizontal load center more than 20 inches (~51cm) from the front of the stock platform (see diagram below).

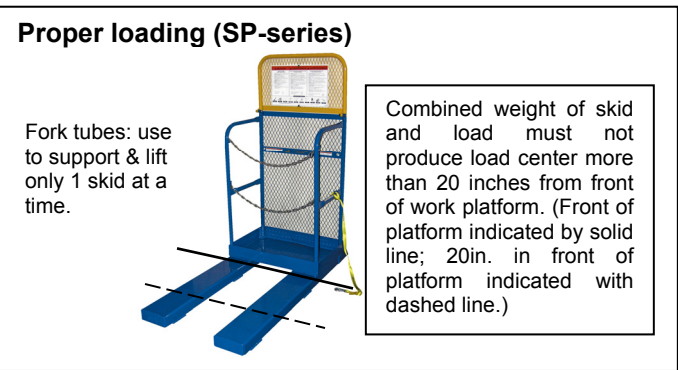
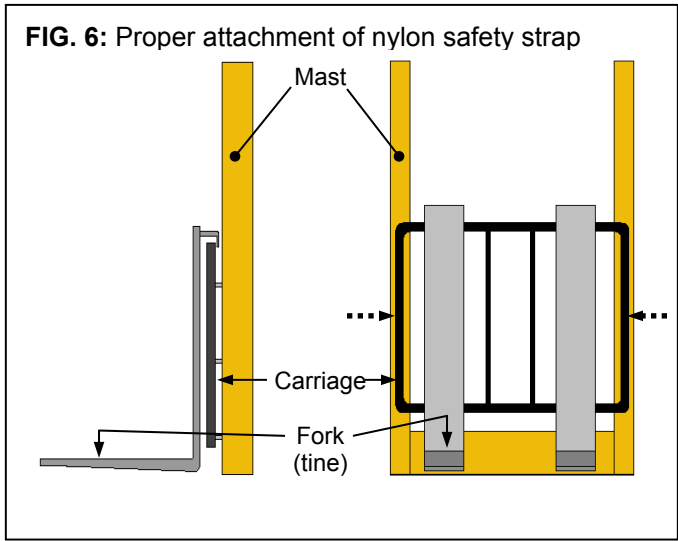

Use instructions:

⚠️WARNING The platform user, fork truck operator, and/or bystanders might sustain serious personal injuries or could be killed if the WP or SP is misused. Occupant(s) or fork truck operators, who disregard obvious hazards, commit product misuse and bear sole responsibility for the consequences. To reduce the likelihood of harmful consequences:

- Both the **WP-series** and **SP-series** products are **medium-duty** rated platforms. **ONLY** use with sit-down rider, high lift fork trucks having a minimum load capacity of 3,000 pounds at a 24" load center.
- ALWAYS review the "Warnings and Safety Instructions" on p.1 before each use.
- ALWAYS apply the operation recommendations of Occupational Safety and Health Administration (OSHA) standard 1910.178 "Powered industrial trucks". (See 29 CFR 1910.178 at <http://ecfr.gpoaccess.gov/cgi/t/text/text-idx?c=ecfr&sid=41e086cb8bf5a6958eb8533944227b80&rqn=div8&view=text&node=29:5.1.1.1.8.14.37.3&idno=29>).
- Apply ANSI/ITSDF B56.1-2005, "Safety Standard for Low Lift and High Lift Trucks," suggestions regarding the use of fork-mounted work platforms. The publication is freely downloadable: <http://www.itsdf.org/pB56.asp>
- **When raised 4 feet (~1.2m) or higher**, any person who occupies the platform must wear a safety harness and lanyard.

SP models: The platform occupant **MUST** attach a lanyard to an anchoring point.

[WP models] Maximum occupancy is 2 persons; **only 1 person per anchoring point**.

[Anchoring points are present at each end of the anchoring weldment. Features are identified in the drawings to the right.]

- Do not lean against the handrails or safety chains.
- Only use the work platform on smooth, level, finished surfaces capable of supporting the combined weight of the person(s) occupying the platform and all equipment and/or material present on the platform, the platform, and the fork lift.

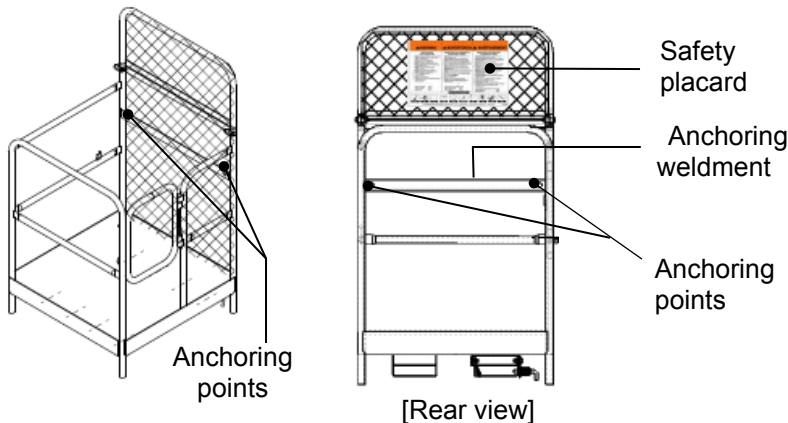

WARNING

(Continued from p. 9)

- Avoid sudden stops or quick turns while transporting the platform.
- **DO NOT drive the fork truck while the platform is occupied.** If it is necessary to reposition the fork truck or to relocate the platform, fully lower the forks, require all persons to disconnect safety lanyards and dismount the platform.
- Set the parking brake before lifting the platform.
- Hold onto the handrail on two sides of the work platform whenever rising or lowering.
- If the platform is equipped with (optional) casters, DO NOT move the platform if it is occupied. Require all persons to get off of the platform AND unload the platform completely BEFORE repositioning or relocating it.

Before entering the work platform, secure the platform to the (fork truck) mast. Inspect all of the platform structure for signs of damage, and verify that the gate latch and / or chain(s) will secure properly.

Model WP: push open the gate to enter the work platform; then release the gate. The gate automatically returns to the closed position. Push outwardly on the gate to confirm that it is locked.

Models having a gate on both sides (WP-####-DD): after entering this work platform from either side, let go of the gate to allow it to close automatically. Confirm that both gates function properly, i.e. fully and automatically close, before proceeding to use the platform.

Model SP-175: enter the platform and then latch both of the safety chains to the D-links. When using the platform to load stock, the forklift driver should orient the platform parallel to the shelving/racking.

Model WP-3737-FD: enter the platform from either side, and then pull the gate closed. Lift the gate, pull the gate fully closed, and then press the gate downward to secure the latch (see "Setup/fold-down instructions"). Confirm that both gates are latched.

Setup / fold-down instructions [Model WP-3737-FD]:

NOTE: Folding the platform creates pinch points. Keep feet, hands and clothing away from pinch points while folding or setting up the work platform.

Step 1: Identify the pegs (welded to the inside of the toeboard and the slots (at the bottoms of the guardrail posts) as shown below.

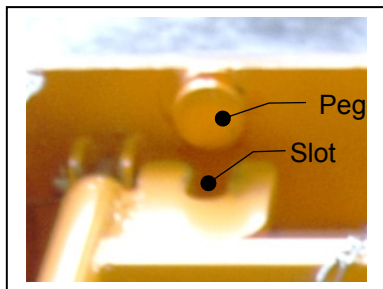

Nylon safety strap

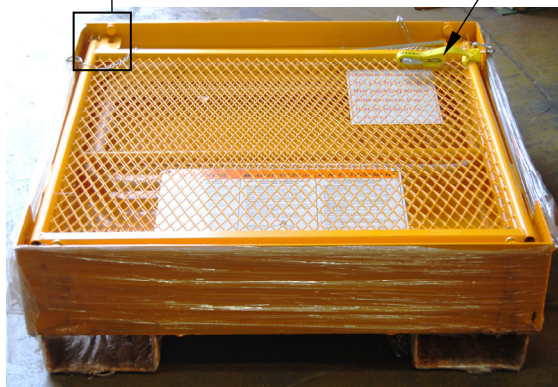

Step 2: Raise the mast guard.



Lift the guard to allow the pegs to fit into the slots.



Step 3: Raise the front guard rail.



Pivot the rail assembly towards the front of the platform.

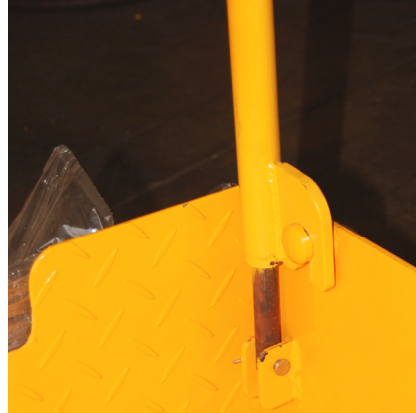

Secure the assembly in place with the pegs and slots.

Step 4: Close and latch the gates.



Lift the gate to allow the slots to slide onto the pegs welded to the toe guard.

Step 5: Secure the platform to the tines of the fork lift.

WARNING The nylon strap is an essential safety-enhancing feature designed to connect the work platform to the carriage of a fork lift. Improperly connecting the nylon safety strap to either the platform or the fork lift might eliminate the safety benefit.

a.) Drive the forklift tines into the fork pockets; then secure the platform to the fork lift with the tine lock (see Step 1 and FIG. 5A & 5B on p. 9).

b.) As delivered, the safety strap is connected to the base of the mast guard (see "Safety strap connection diagram" on p. 9).



WP-3737-FD labeling diagram:

The work platform should always be labeled as shown in the diagram below. Replace every label that becomes damaged or unreadable.

Sign 082 (on back of mast guard facing forklift)

| WARNING | |
|---|--|
| SECURELY ATTACH PLATFORM TO FORKLIFT with safety strap and tine lock | |
| DO NOT MOVE LIFT WITH PLATFORM OCCUPIED <small>See reverse side for complete instructions</small> | |
| ADVERTENCIA | AVERTISSEMENT |
| ASEGURE LA PLATAFORMA A LA TRANSPALETA con la correa de seguridad y el cierre | ATTACHER SOLIDEMENT LA PLATE-FORME AU CHARIOT ELEVATEUR A FOURCHE avec attache de sécurité et serrure |
| NO MUEVA LA PLATAFORMA HACIA DELANTE O HACIA DETRAS SI ESTA OCUPADA <small>Vea el reverso para instrucciones completas</small> | NE PAS BOUGER EN AVANT OU EN ARRIERE LA PLATE-FORME DE TRAVAIL SI ELLE EST OCCUPEE <small>Regarder au verso pour les instructions completes</small> |

Sign 080 (facing platform)

| WARNING | ADVERTENCIA | AVERTISSEMENT |
|---|--|--|
| <p>ATTENTION TO ELECTRICAL SAFETY</p> <p>BEFORE WORKING ON ELECTRICAL SYSTEMS, DISCONNECT FROM MAIN POWER. ALWAYS USE APPROPRIATE SAFETY PROCEDURES TO AVOID ELECTRICAL SHOCK.</p> <p>Always use proper safety procedures when working on electrical systems. Disconnect from main power before working on electrical systems. Always use appropriate safety procedures to avoid electrical shock.</p> <p>Always use proper safety procedures when working on electrical systems. Disconnect from main power before working on electrical systems. Always use appropriate safety procedures to avoid electrical shock.</p> <p>Always use proper safety procedures when working on electrical systems. Disconnect from main power before working on electrical systems. Always use appropriate safety procedures to avoid electrical shock.</p> | <p>PRECAUCION DE SEGURIDAD EN LA MANEJA DE EQUIPOS ELÉCTRICOS</p> <p>ANTES DE TRABAJAR EN SISTEMAS ELÉCTRICOS, DESCONECTE DEL ALIMENTACIÓN PRINCIPAL. SIEMPRE USE PROCEDIMIENTOS ADECUADOS PARA EVITAR GOLPES ELÉCTRICOS.</p> <p>Siempre use procedimientos adecuados de seguridad al trabajar en sistemas eléctricos. Desconecte de la alimentación principal antes de trabajar en sistemas eléctricos. Siempre use procedimientos adecuados de seguridad para evitar golpes eléctricos.</p> <p>Siempre use procedimientos adecuados de seguridad al trabajar en sistemas eléctricos. Desconecte de la alimentación principal antes de trabajar en sistemas eléctricos. Siempre use procedimientos adecuados de seguridad para evitar golpes eléctricos.</p> <p>Siempre use procedimientos adecuados de seguridad al trabajar en sistemas eléctricos. Desconecte de la alimentación principal antes de trabajar en sistemas eléctricos. Siempre use procedimientos adecuados de seguridad para evitar golpes eléctricos.</p> | <p>ATTENTION À LA SÉCURITÉ ÉLECTRIQUE</p> <p>AVANT DE TRAVAILLER SUR DES SYSTÈMES ÉLECTRIQUES, DÉCONNECTEZ-VOUS DE L'ALIMENTATION PRINCIPALE. TOUJOURS UTILISER DES PROCÉDURES DE SÉCURITÉ APPROPRIÉES POUR ÉVITER DES CHOC ÉLECTRIQUES.</p> <p>Utilisez toujours des procédures de sécurité appropriées lorsqu'il s'agit de travailler sur des systèmes électriques. Déconnectez-vous de l'alimentation principale avant de travailler sur des systèmes électriques. Utilisez toujours des procédures de sécurité appropriées pour éviter les chocs électriques.</p> <p>Utilisez toujours des procédures de sécurité appropriées lorsqu'il s'agit de travailler sur des systèmes électriques. Déconnectez-vous de l'alimentation principale avant de travailler sur des systèmes électriques. Utilisez toujours des procédures de sécurité appropriées pour éviter les chocs électriques.</p> <p>Utilisez toujours des procédures de sécurité appropriées lorsqu'il s'agit de travailler sur des systèmes électriques. Déconnectez-vous de l'alimentation principale avant de travailler sur des systèmes électriques. Utilisez toujours des procédures de sécurité appropriées pour éviter les chocs électriques.</p> |

Label 218 (on toeboard, both sides of platform)

| WARNING | ADVERTENCIAS |
|---|--|
| <p>Improper use might result in death or serious personal injury. Attach device to fork carriage with safety chain/strap.</p> <ul style="list-style-type: none"> Drive lift truck forward until forks contact ends of fork pockets. Chain/strap must not be able to disconnect (slide free) from carriage. Safety chain/strap must be taut. Connect chain/strap to carriage via shortest line. | <p>El uso inadecuado puede resultar en muerte o heridas personales. Asegure el dispositivo al mástil del montacargas con cadenas/correas.</p> <ul style="list-style-type: none"> Maneje el montacargas para adelante hasta que las puntas de las carcasas hagan contacto con la orilla del bolsillo de las carcasas. La cadena y correa no deben de deslizarse (solzarse) del mástil del montacargas. La cadena/correa de seguridad debe de estar apretada. |

Label 253 (facing platform)

| WARNING | ADVERTENCIA | AVERTISSEMENT |
|--|--|--|
| FASTEN PERSONAL FALL ARREST EQUIPMENT HERE | AGARRE EL EQUIPO PERSONAL DE CAIDAS AQUI | ATTACHER PROTECTION ANTICHUTE INDIVIDUELLE ICI |

Label 821

SAFETY FIRST SEGURIDAD PRIMERO
Read manual carefully and follow safety instructions. Lea el manual del propietario y todas las etiquetas antes del uso.

Label 287 (on toeboard)

| | |
|--|------|
| MODEL/MODELO/MODELE | |
| STATIC CAPACITY (evenly distributed) | lbs. |
| LA CAPACIDAD CONSTANTE (distribuida uniformemente) | kgs. |
| CAPACITÉ STATIQUE (distribuée régulièrement) | kgs. |
| SERIAL/SERIE/SÉRIE | |

287 REV 0812

Label 729

DANGER
METAL CONDUCTS ELECTRICITY!
DO NOT CONTACT LIVE WIRES

Instructions for mounting casters to platform models WP-3636, -3648, & -4848:

WARNING Improperly installed, utilized, or maintained casters could make the platform unsafe to use. To reduce the likelihood of serious injury:

- READ EACH INSTRUCTION BEFORE BEGINNING THE INSTALLATION.
- Inspect the casters regularly for damage and to verify that the caster stem is still inserted fully and that it is securely held inside the post.
- Only use the casters on flat, even, solid surfaces.
- DO NOT move the platform when loaded with equipment or personnel. Only move the platform by means of the casters if completely unloaded AND unoccupied.
- Forklift operator: DO NOT lower the platform onto the casters at a rate greater than one foot per second. Gently lower the platform onto the casters to avoid damaging them.

1. Verify that the bottoms of all four of the handrail posts are undamaged and free of foreign material (inside the posts).
2. Raise the work platform high enough to allow the casters to be inserted into the bottom of each of the four posts.
3. Examine each caster; verify that each has a plastic spacer, a black rubber expansion sleeve, and a knurled nut as shown in Figure A.
4. Hold onto the 2½" tightening hub at the top of the caster rig with your hand and snug the knurled nut against the top rubber expansion sleeve.
5. Insert the caster stem into the bottom of the post until the tightening hub is up against the bottom of the handrail post.
6. Turn the tightening hub counterclockwise. If the hub doesn't tighten, apply side pressure to the caster while turning the hub. **Note:** The tightening hub must maintain contact with the bottom of the corner handrail post during tightening.
7. After hand-tightening the hub, pull down on the caster rig to verify that the caster is secured in the post.

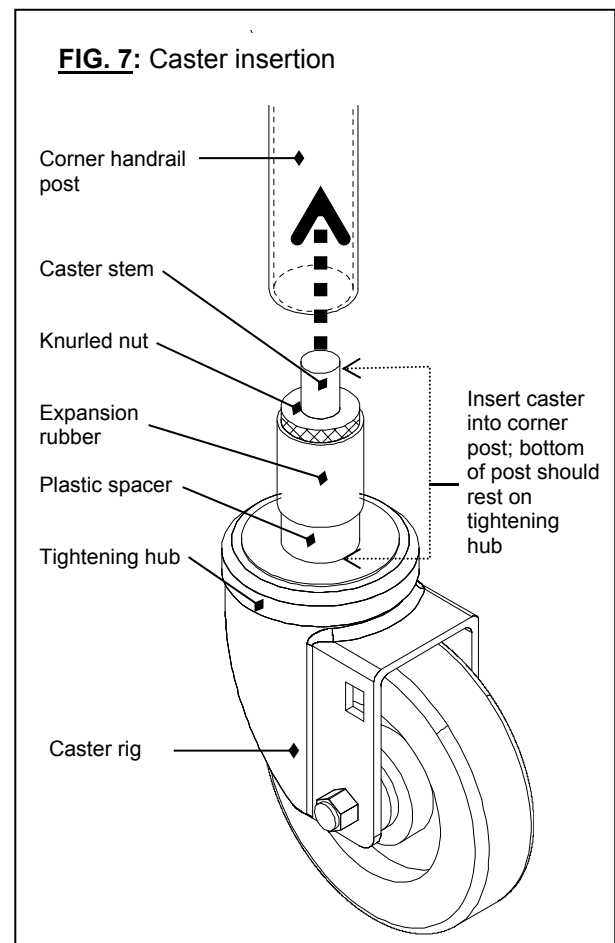

Emergency stop switch installation:

NOTICE The instructions apply ONLY to LP or gasoline powered fork trucks. If the truck designated for use with work platforms is powered either by battery or diesel fuel, contact the truck manufacturer for installation directions.

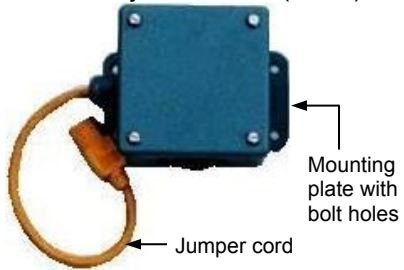
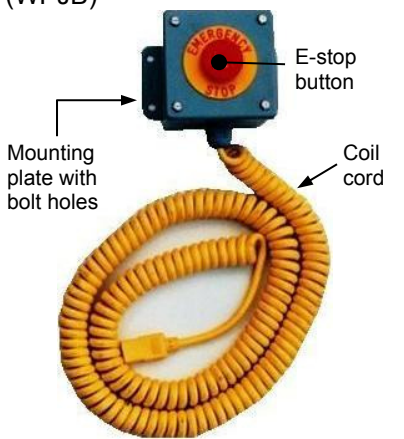
| Item No. | Description | Quantity |
|----------|---|----------|
| 1 | ¼ in. - 20 x 1in. | 8 |
| 2 | ¼ in. - 20 lock nut | 8 |
| 3 | ¼ in. flat washer | 8 |
| 4 | ¼ in. fender washer | 4 |
| 5 | Fork truck junction box (FTJB)  | 1 |
| 6 | Work platform junction box (WPJB)  | 1 |

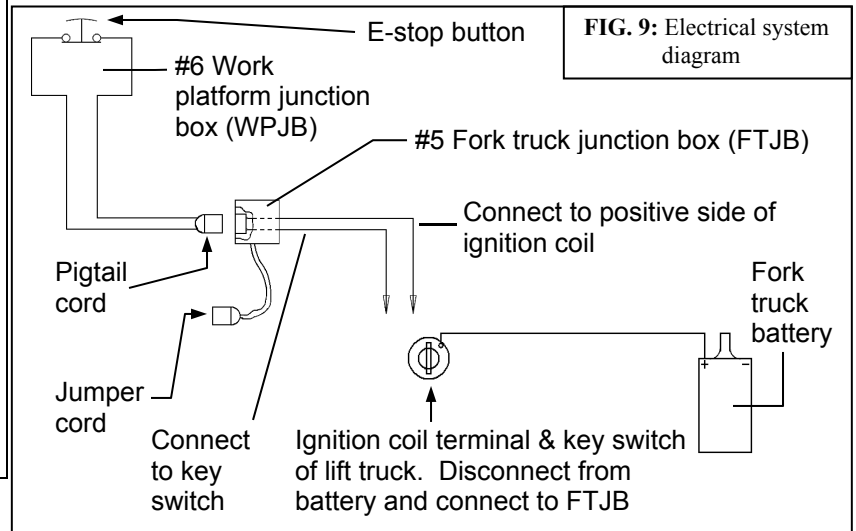
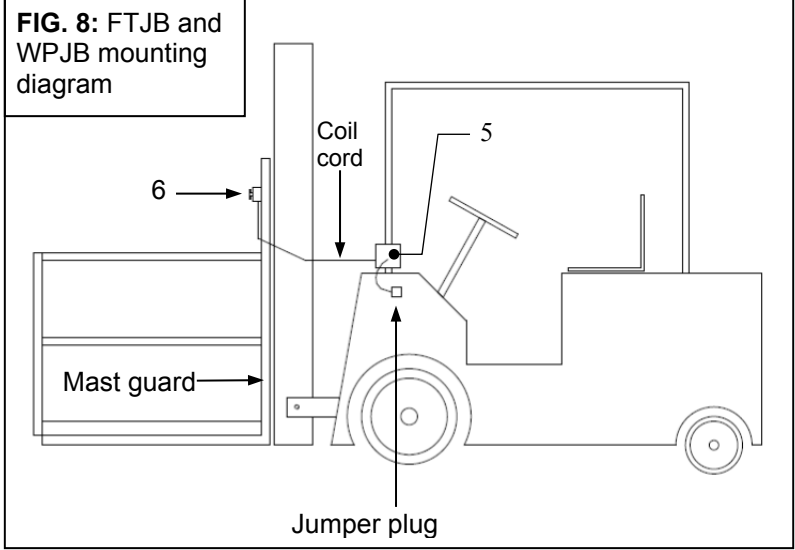

1) Mount the fork truck junction box (5) in an appropriate place on the designated fork lift (for instance, on the operator roll cage/ overhead guard as shown in FIG. 8 & 9 above). Fasten junction box (5) to the lift truck with 4 bolts, 4 flat washers, and 4 lock nuts.

2) Disconnect the wire leading from the ignition coil (key switch) of the lift truck. Attach the wire to 1 of the receptacle terminals inside the fork truck junction box (5).

3) Connect the appropriate wire from the (ignition) key switch to the other receptacle terminal inside the junction box (5).

4) Mount the work platform junction box (6) to the mast guard. Position the junction box as shown in Fig. 10. Fasten the WPJB to the inside surface of the mast guard. Proper fastener order is shown in Fig. 11.

Use Instructions

a) To operate the fork truck without platform attached: plug the FTJB jumper cord into the socket in the FTJB (connect the fork truck junction box to itself).

b) Work platform attached: unplug the jumper cord from the FTJB socket; then plug the male plug of the coil cord into the socket of the FTJB. Pull the E-stop button out.

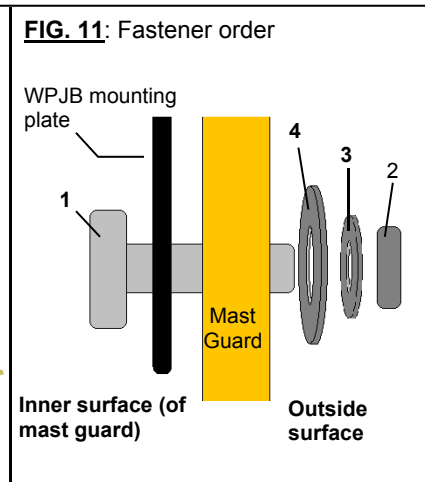
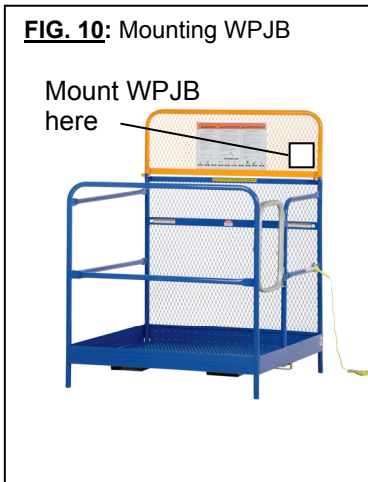

Labeling diagram:

The work platform should always be labeled as shown in the diagram below. Replace every label that becomes damaged or unreadable.

WP-series platforms:

Sign 080



Sign 082 (facing lift truck)



Label 729



Label 922

California and some other jurisdictions require fork-mounted work platforms be equipped with mast guards 84 inches high. Before using this device, check for requirements in state and local authorities where the platform will be used.

Label 287 (covered with 815 overlay)

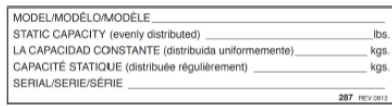

Label 821



Label 253 (applied in 2 places)



Label 218 (on toeboard)

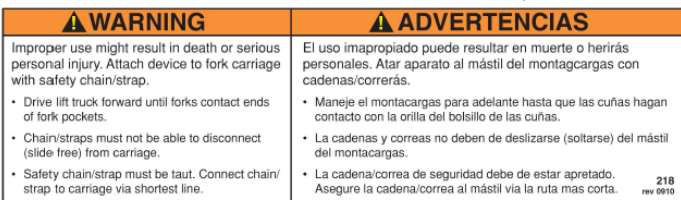

Labeling diagram:

The work platform should always be labeled as shown in the diagram below. Replace every label that becomes damaged or unreadable.

SP-series platforms:

Sign 080

| ⚠️ WARNING | ⚠️ ADVERTENCIA | ⚠️ AVERTISSEMENT |
|---|--|--|
| WORK PLATFORM SAFETY INSTRUCTIONS SEATO OR STROUK NIEUW NIET RESULT A BERUDELSIJDEN. | INSTRUCCIONES DE SEGURIDAD DE LA PLATAFORMA DE TRABAJO LA SEUREID E INSTRUCCIONES DE SEGURIDAD PERSONAL DEBE SER SIEMPRE LEÍDA. | INSTRUCTIONS DE SECURITE POUR LA PLATE-FORME DE TRAVAIL LES INSTRUCTIONS DE SECURITE PERSONNELLE DOIVENT TOUJOURS ETRE LUES. |
| <p>1. This platform complies with CE/EN 12178 (Work Platform Safety) and CE/EN 12179 (Personal Protective Equipment) standards. It is intended for use on a forklift truck.</p> <p>2. The user must be trained and instructed in the use of this platform.</p> <p>3. The user must wear the seat belt and use the safety harness and fall arrest system correctly.</p> <p>4. The user must not drink alcohol or use drugs before using the platform.</p> <p>5. The user must not use the platform if they are dizzy, tired or otherwise physically or mentally unfit for the task.</p> <p>6. The user must not use the platform if they are wearing shoes that are not suitable for the task.</p> <p>7. The user must not use the platform if they are carrying a load that exceeds the rated capacity.</p> <p>8. The user must not use the platform if they are in a restricted area or near overhead power lines.</p> <p>9. The user must not use the platform if they are in a confined space.</p> <p>10. The user must not use the platform if they are in a hazardous environment.</p> <p>11. The user must not use the platform if they are in a wet or slippery surface.</p> <p>12. The user must not use the platform if they are in a high-traffic area.</p> <p>13. The user must not use the platform if they are in a narrow aisle.</p> <p>14. The user must not use the platform if they are in a confined space.</p> <p>15. The user must not use the platform if they are in a hazardous environment.</p> | <p>1. Este equipo cumple con las normas CE/EN 12178 (Seguridad de las Plataformas de Trabajo) y CE/EN 12179 (Equipamiento de Protección Personal). Está diseñado para ser utilizado en un tractor de carretilla.</p> <p>2. El usuario debe estar formado e instruido en el uso de esta plataforma.</p> <p>3. El usuario debe utilizar el cinturón de seguridad y el sistema de arnés y dispositivo de parada de caída correctamente.</p> <p>4. El usuario no debe beber alcohol o utilizar drogas antes de utilizar la plataforma.</p> <p>5. El usuario no debe utilizar la plataforma si está mareado, cansado o si está físicamente o mentalmente incapaz de realizar el trabajo.</p> <p>6. El usuario no debe utilizar la plataforma si está utilizando zapatos que no sean adecuados para el trabajo.</p> <p>7. El usuario no debe utilizar la plataforma si está cargando una carga que exceda la capacidad nominal.</p> <p>8. El usuario no debe utilizar la plataforma si está en un área restringida o cerca de líneas eléctricas aéreas.</p> <p>9. El usuario no debe utilizar la plataforma si está en un espacio confinado.</p> <p>10. El usuario no debe utilizar la plataforma si está en un entorno peligroso.</p> <p>11. El usuario no debe utilizar la plataforma si está en una superficie húmeda o resbaladiza.</p> <p>12. El usuario no debe utilizar la plataforma si está en una zona de alto tráfico.</p> <p>13. El usuario no debe utilizar la plataforma si está en un pasillo estrecho.</p> <p>14. El usuario no debe utilizar la plataforma si está en un espacio confinado.</p> <p>15. El usuario no debe utilizar la plataforma si está en un entorno peligroso.</p> | <p>1. Ce matériel respecte les normes CE/EN 12178 (Norme Sécurité des Plateformes de Travail) et CE/EN 12179 (Norme Équipement de Protection Personnelle). Il est conçu pour être utilisé sur un chariot élévateur.</p> <p>2. L'utilisateur doit être formé et instruit dans l'utilisation de cette plateforme.</p> <p>3. L'utilisateur doit porter la ceinture de sécurité et utiliser correctement le harnais de sécurité et le système d'arrêt de chute.</p> <p>4. L'utilisateur ne doit pas boire d'alcool ou utiliser de drogues avant d'utiliser la plateforme.</p> <p>5. L'utilisateur ne doit pas utiliser la plateforme s'il est éméché, fatigué ou s'il est physiquement ou mentalement incapable de réaliser le travail.</p> <p>6. L'utilisateur ne doit pas utiliser la plateforme s'il porte des chaussures inadaptées au travail.</p> <p>7. L'utilisateur ne doit pas utiliser la plateforme s'il transporte une charge qui excède la capacité nominale.</p> <p>8. L'utilisateur ne doit pas utiliser la plateforme s'il est dans une zone restreinte ou près de lignes électriques aériennes.</p> <p>9. L'utilisateur ne doit pas utiliser la plateforme s'il est dans un espace confiné.</p> <p>10. L'utilisateur ne doit pas utiliser la plateforme s'il se trouve dans un environnement dangereux.</p> <p>11. L'utilisateur ne doit pas utiliser la plateforme sur une surface humide ou glissante.</p> <p>12. L'utilisateur ne doit pas utiliser la plateforme s'il se trouve dans une zone à fort trafic.</p> <p>13. L'utilisateur ne doit pas utiliser la plateforme dans un couloir étroit.</p> <p>14. L'utilisateur ne doit pas utiliser la plateforme s'il est dans un espace confiné.</p> <p>15. L'utilisateur ne doit pas utiliser la plateforme s'il se trouve dans un environnement dangereux.</p> |
| <p>Minimum height capacity _____ lbs.</p> <p>Minimum floor capacity _____ lbs.</p> <p>Platform weight _____ lbs.</p> | <p>Capacidad mínima de altura _____ kg.</p> <p>Capacidad máxima de peso _____ kg.</p> <p>Peso de la plataforma _____ kg.</p> | <p>Capacité minimale de hauteur élévateur à fourches _____ kg.</p> <p>Capacité maximale de poids _____ kg.</p> <p>Poids de la plateforme _____ kg.</p> |

Sign 082 (facing forklift on back)

| ⚠️ WARNING | |
|---|--|
| SECURELY ATTACH PLATFORM TO FORKLIFT with safety strap and tine lock | |
| DO NOT MOVE LIFT WITH PLATFORM OCCUPIED See reverse side for complete instructions | |
| ⚠️ ADVERTENCIA | ⚠️ AVERTISSEMENT |
| ASEGURE LA PLATAFORMA A LA TRANSPALET con la correa de seguridad y el cierre | ATTACHER SOLIDEMENT LA PLATE-FORME AU CHARIOT ELEVATEUR A FOURCHE avec attache de sécurité et serrure de bras de fourche |
| NO MUEVA LA PLATAFORMA HACIA DELANTE O HACIA DETRAS SI ESTA OCUPADA Vea al reverso para instrucciones completas | NE PAS BOUGER EN AVANT OU EN ARRIERE LA PLATE-FORME DE TRAVAIL SI ELLE EST OCCUPEE Regarder au verso pour les instructions complètes |

Label 821

| | |
|---|--|
| SAFETY FIRST | SEGURIDAD PRIMERO |
| Read owners manual and all labels before using. | Lea el manual del propietario y todas las etiquetas antes del uso. |

Label 729

| |
|------------------------------------|
| DANGER |
| METAL CONDUCTS ELECTRICITY! |
| DO NOT CONTACT LIVE WIRES |

Label 287 (covered with label 815)

| | |
|--|--------------|
| MODEL/MODELO/MOДЕЛЕ _____ | |
| STATIC CAPACITY (evenly distributed) _____ | lbs. |
| LA CAPACIDAD CONSTANTE (distribuida uniformemente) _____ | kgs. |
| CAPACITÉ STATIQUE (distribuée régulièrement) _____ | kgs. |
| SERIAL/SERIE/SÉRIE _____ | |
| | 287 REV 0812 |

Label 253 (both sides)

| ⚠️ WARNING | ⚠️ ADVERTENCIA | ⚠️ AVERTISSEMENT |
|---|---|---|
| FASTEN PERSONAL FALL ARREST EQUIPMENT HERE | AGARRE EL EQUIPO PERSONAL DE CAIDAS AQUI | ATTACHER PROTECTION ANTICHUTE INDIVIDUELLE ICI |

Label 218 (both sides)

| ⚠️ WARNING | ⚠️ ADVERTENCIAS |
|---|--|
| Improper use might result in death or serious personal injury. Attach device to fork carriage with safety chain/strap. | El uso impropio puede resultar en muerte o heridas personales. Atar aparato al mástil del montacargas con cadenas/correas. |
| <ul style="list-style-type: none"> Drive till truck forward until forks contact ends of forkpockets Chain/straps must not be able to disconnect while they're on carriage. Safety chain/strap must be taut. Connect chain/strap to carriage via shortest line. | <ul style="list-style-type: none"> Mantéjate al montacargas para adelante hasta que las cuñas hagan contacto con la colilla del botillo de las cuñas. Las cadenas y correas no deben de deslizarse (solzarse) del mástil del montacargas. La cadena/correa de seguridad debe de estar apretado. Asegure la cadena/correa al mástil vía la ruta mas corta. |



LIMITED WARRANTY

Vestil Manufacturing Corporation ("Vestil") warrants this product to be free of defects in material and workmanship during the warranty period. Our warranty obligation is to provide a replacement for a defective original part if the part is covered by the warranty, after we receive a proper request from the warrantee (you) for warranty service.

Who may request service?

Only a warrantee may request service. *You are a warrantee if* you purchased the product from Vestil or from an authorized distributor AND Vestil has been fully paid.

What is an "original part"?

An original part is a part used to make the product as shipped to the warrantee.

What is a "proper request"?

A request for warranty service is proper if Vestil receives: 1) a photocopy of the Customer Invoice that displays the shipping date; AND 2) a written request for warranty service including your name and phone number. Send requests by any of the following methods:

Mail
Vestil Manufacturing Corporation
2999 North Wayne Street, PO Box 507
Angola, IN 46703

Fax
(260) 665-1339
Phone
(260) 665-7586

Email
sales@vestil.com

In the written request, list the parts believed to be defective and include the address where replacements should be delivered.

What is covered under the warranty?

After Vestil receives your request for warranty service, an authorized representative will contact you to determine whether your claim is covered by the warranty. Before providing warranty service, Vestil may require you to send the entire product, or just the defective part or parts, to its facility in Angola, IN. The warranty covers defects in the following original dynamic components: motors, hydraulic pumps, electronic controllers, switches and cylinders. It also covers defects in original parts that wear under normal usage conditions ("wearing parts"), such as bearings, hoses, wheels, seals, brushes, and batteries.

How long is the warranty period?

The warranty period for original dynamic components is 90 days. For wearing parts, the warranty period is 90 days. The warranty periods begin on the date when Vestil ships the product to the warrantee. If the product was purchased from an authorized distributor, the periods begin when the distributor ships the product. Vestil may, at its sole discretion, extend the warranty periods for products shipped from authorized distributors by up to 30 days to account for shipping time.

If a defective part is covered by the warranty, what will Vestil do to correct the problem?

Vestil will provide an appropriate replacement for any covered part. An authorized representative of Vestil will contact you to discuss your claim.

What is not covered by the warranty?

1. Labor;
2. Freight;
3. Occurrence of any of the following, which automatically voids the warranty:
 - Product misuse;
 - Negligent operation or repair;
 - Corrosion or use in corrosive conditions;
 - Inadequate or improper maintenance;
 - Damage sustained during shipping;
 - Accidents involving the product;
 - Unauthorized modifications: DO NOT modify the product IN ANY WAY without first receiving written authorization from Vestil. Modification(s) might make the product unsafe to use or might cause excessive and/or abnormal wear.

Do any other warranties apply to the product?

Vestil Manufacturing Corp. makes no other express warranties. All implied warranties are disclaimed to the extent allowed by law. Any implied warranty not disclaimed is limited in scope to the terms of this Limited Warranty.

