

# IND221

# IND226

## Industry Terminal User/Service Manual



**METTLER TOLEDO**

182837 (2006-2-8)

# PRECAUTIONS

READ this manual BEFORE operating or servicing this equipment.



FOLLOW these instructions carefully.



SAVE this manual for future reference.

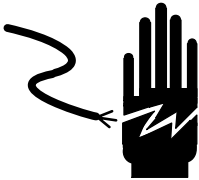

DO NOT allow untrained personnel to operate, clean, inspect, maintain, service, or tamper with this equipment.

ALWAYS DISCONNECT this equipment from the power source before cleaning or performing maintenance.

Note: If the unit has been stored or transported in below freezing temperatures, allow the unit to warm up to room temperature before turning on AC power.

	 <b>WARNING</b>
	DISCONNECT ALL POWER TO THIS UNIT BEFORE INSTALLING, SERVICING, CLEANING, OR REMOVING THE FUSE. FAILURE TO DO SO COULD RESULT IN BODILY HARM AND/OR PROPERTY DAMAGE.

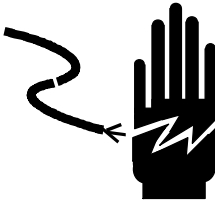
	 <b>CAUTION</b>
	OBSERVE PRECAUTIONS FOR HANDLING ELECTROSTATIC SENSITIVE DEVICES.

	 <b>WARNING</b>
	ONLY PERMIT QUALIFIED PERSONNEL TO SERVICE THIS EQUIPMENT. EXERCISE CARE WHEN MAKING CHECKS, TESTS AND ADJUSTMENTS THAT MUST BE MADE WITH POWER ON. FAILING TO OBSERVE THESE PRECAUTIONS CAN RESULT IN BODILY HARM.

	 <b>WARNING</b>
	FOR CONTINUED PROTECTION AGAINST SHOCK HAZARD, CONNECT TO PROPERLY GROUNDED OUTLET ONLY. DO NOT REMOVE THE GROUND PRONG.



## CAUTION

BEFORE CONNECTING OR DISCONNECTING ANY INTERNAL ELECTRONIC COMPONENTS OR INTERCONNECTING WIRING BETWEEN ELECTRONIC EQUIPMENT, ALWAYS REMOVE POWER AND WAIT AT LEAST THIRTY (30) SECONDS BEFORE ANY CONNECTIONS OR DISCONNECTIONS ARE MADE. FAILURE TO OBSERVE THESE PRECAUTIONS COULD RESULT IN DAMAGE TO OR DESTRUCTION OF THE EQUIPMENT, OR BODILY HARM.



## CAUTION

THE IND226 SOCKET-OUTLET SHALL BE INSTALLED NEAR THE EQUIPMENT AND SHALL BE EASILY ACCESSIBLE.



## CAUTION

RISK OF EXPLOSION IF BATTERY IS REPLACED BY AN INCORRECT TYPE. DISPOSE OF USED BATTERIES ACCORDING TO THE INSTRUCTIONS



## CAUTION

REPLACE THE FUSES ONLY BY SERVICE PERSONNEL

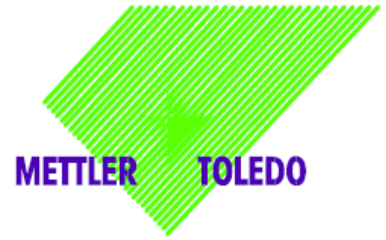

**Declaration of Conformity**  
Konformitätserklärung  
Déclaration de conformité  
Declaración de Conformidad  
Conformiteitsverklaring  
Dichiarazione di conformità

We

Mettler-Toledo (ChangZhou) Scale & System Ltd.  
111 ChangXi Road, ChangZhou, JiangSu, 213001, P.R.China

declare under our sole responsibility that the product,  
erklären, in alleiniger Verantwortung, daß dieses Produkt,  
déclarons sous notre seule responsabilité que le produit,  
declaramos, bajo nuestra sola responsabilidad, que el producto,  
verklaren onder onze verantwoordelijkheid, dat het product,  
dichiariamo sotto nostra unica responsabilità, che il prodotto,

Model/Type: IND22x series indicator

To which this declaration relates, is in conformity with the following standard(s) or other normative document(s),  
auf das sich diese Erklärung bezieht, mit der/den folgenden Norm(en) oder Richtlinie(n) übereinstimmt.  
Auquel se réfère cette déclaration est conforme à la (aux) norme(s) ou au(x) document(s) normatif(s).  
Al que se refiere esta declaración es conforme a la(s) norma(s) u otro(s) documento(s) normativo(s).  
Waarnaar deze verklaring verwijst, aan de volende norm(en) of richtlijn(en) beantwoordt.  
A cui si riferisce questa dichiarazione è conforme alla/e seguente/i norma/e o documento/i normativo/i.

EC marking	EC Directive:	Applicable Standards:
	73/23/EEC Low Voltage Directive	EN60950-1:2001
	89/336/EEC EMC Directive	EN61326:1997+A1+A2 (Class B) EN61000-3-2 / 3-3 EN61000-4-2 / 4-4 / 4-5 / 4-11 EN61000-4-3 (10 V/m) EN61000-4-6 (10 V/m)
Year 0103	90/384/EEC Non-automatic Weighing Instruments Directive	EN45501 (See note 1) Test certificate number TC6862

1) applies only to certified non-automatic weighing instruments in connection with an approved and compatible weighing platform.

111 ChangXi Road, ChangZhou, JiangSu, 213001, PRC, January 26, 2006, Mettler-Toledo (ChangZhou) Scale & System Ltd.

Yang JiaWu  
Quality Assurance Manager

Important notice for Verified weighing instruments in EC countries.

the application of the Green M indicates that the non-automatic weighing instrument has been verified at the place of manufacturer.

# Contents

1.0	Overview .....	1
1.1	Specification .....	1
1.2	Main functions .....	1
1.3	Dimensions .....	2
1.4	Order information .....	2
2.0	Install .....	3
2.1	Open the package .....	3
2.2	Electronic Connect.....	3
2.2.1	Open the terminal.....	3
2.2.2	Load Cell Connect .....	3
2.2.3	Com1 RS232.....	4
2.3	Lead seal .....	5
2.4	Battery Pack Option.....	5
2.4.1	Battery install .....	5
2.4.2	Recharge Battery .....	6
2.4.3	Use Battery.....	6
3.0	Operation .....	7
3.1	Operation HMI.....	7
3.2	Basic function operation .....	7
3.2.1	On/Off key .....	7
3.2.2	Zero .....	7
3.2.3	Tare .....	7
3.2.4	Clear.....	8
3.2.5	Print.....	8
3.3	Expand functions .....	8
3.3.1	X10 Function .....	8
3.3.2	Unit switch.....	8
3.3.3	Over/Under Function .....	8
3.3.4	Counting Function.....	10
4.0	Setup .....	11
4.1	Enter Setup.....	11
4.2	Keys in setup.....	11
4.3	Setup Detail.....	9
5.0	Terminal Maintenance.....	15
5.1	Daily maintenance .....	15
5.2	Error Messages.....	15
5.3	Software download .....	16

# 1.0 Overview

## 1.1 Specification

- 6 digits 1.2" large green LED display. Robust long life.
- 6 Function keys, Simple and easy.
- IND221: Plastic, Protection IP54.
- IND226: Stainless steel, Protection: IP69K.
- Executive voltage: +5VDC.
- Load Cell capability: Maximum 4-350ohm analog load cell.
- Zero signal input ranges: 0~5mV.
- SPAN signal input ranges: 1~10mV.
- Resolution: 1,000,000.
- Increments: 1,000 ~ 30,000
- A/D Rates: 27 /seconds.
- Working voltage: AC87~264VAC, 0.1A  
DC: NI-HM rechargeable battery (Optional)  
DC: C Size Dry Battery(Optional)
- RS232 Serial port
- Working temperature: -10°C - +40°C, Relative Humidity < 85%.
- Storage temperature: -20°C - +60°C, Relative Humidity < 85%.

## 1.2 Main functions

- Basic weighing: Zero, Tare, Clear, Print.
- Auto print function.
- Units switch: kg,lb.
- x10 function / Simple check weighing / Counting.
- English/Chinese print formats.
- Support ticket micro printer.
- Power saving technology. Low battery icon.
- Auto power off.

### 1.3 Dimensions

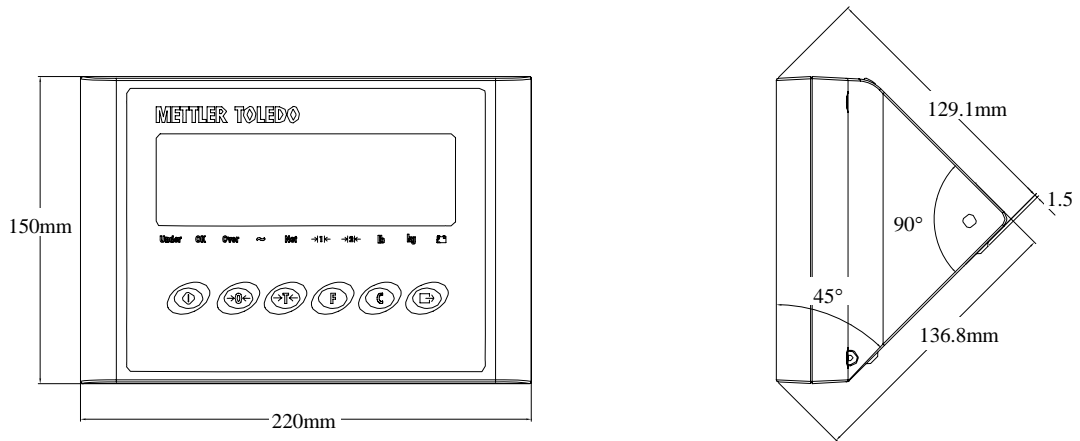

IND221

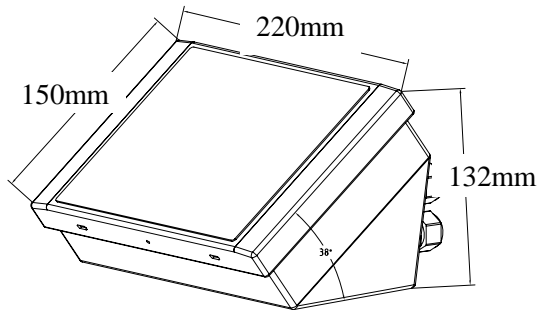

IND226

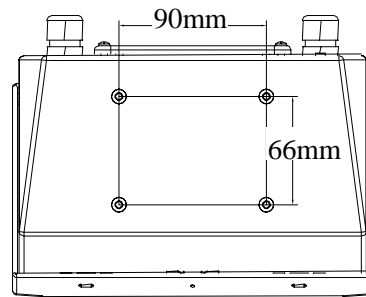

### 1.4 Order information

Model Name	Descriptions	P/N
IND221-1000	Plastic Standard (with dry case)	72183995
IND221-1001	Plastic With rechargeable battery	72183997
IND226-1000	Harsh, Standard	72183987
IND226-1001	Harsh, With rechargeable battery	72183989

## 2.0 Install

This part will talking about the Installation for IND221 and IND226. Please read this chapter carefully before install.

### 2.1 Open the package

Open the package, And check all the parts with the checklist. Make sure no part was damaged and missing.

Remove the terminal from its protective package,

### 2.2 Electronic Connect

#### 2.2.1 Open the terminal

The IND221 terminal use 4 screws to lock the front cover.

The front panel of the IND226 terminal is locked in place by four spring clips attached to the enclosure body. To gain access to the terminal's PCB for internal wiring and setting switches, separate the front panel from the enclosure as follows:

Insert the tip of a flat-blade screwdriver into one of the two slots located on the bottom of the front panel assembly and gently push in toward the enclosure. A “pop” sound is made when the cover is released.

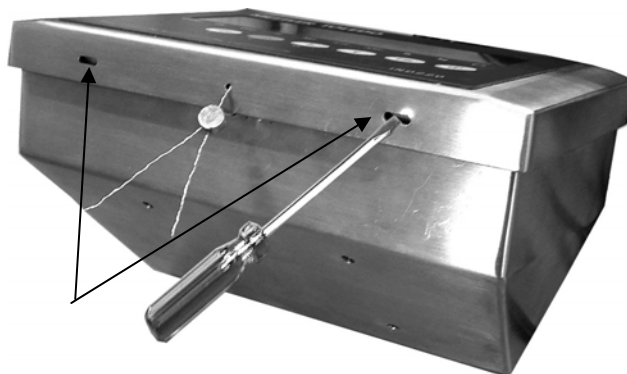

#### 2.2.2 Load Cell Connect

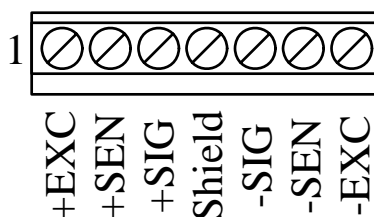

7 Pins terminal strip.

Pin 1 - +EXC

Pin 2 - +SEN

Pin 3 - +SIG

Pin 4 - Shield



- Pin 5 - -SIG
- Pin 6 - -SEN
- Pin 7 - -EXC

For 4 wires load cell, you should short the W1 two pins, and short the W2 two pins in PCB.

IND221 use PG9 cable bush grip, the allow cable diameter is 4 to 9mm.

IND226 use PG11 cable bush grip, the allow cable diameter is 5 to 10mm.

We recommend use CMX or CM cables for load cell connect.

The cable information:

Type: CMX, CM

Parameter:  $6 \times 0.2 \text{mm}^2$

Voltage: Max. 380V

Temperature range:  $-30 \sim +80^\circ$

Cable diam:  $6.1 \pm 0.15 \text{mm}$ .

Isolation material: UBEC180 polyethylene.

Protection jacket:  $90^\circ \text{C}$  HZ-90(318#)

### 2.2.3 Com1 RS232

#### IND221:



RS232 use D-Sub Male connector

- Pin 2 — RXD
- Pin 3 — TXD
- Pin 5 — GND

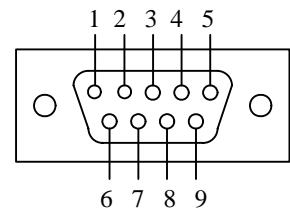

#### IND226:

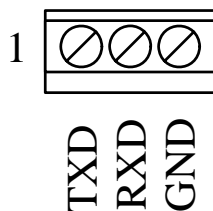

Serial port use 3 Pins terminal strip.

- Pin 1 - TXD
- Pin 2 - RXD
- Pin 3 - GND

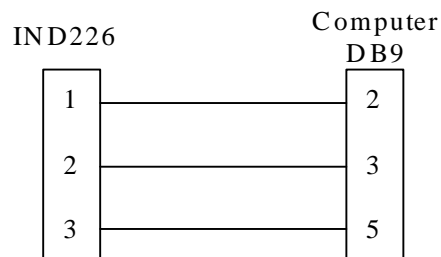

## 2.3 Lead seal

After setup and calibration you can seal the terminal.

IND221:

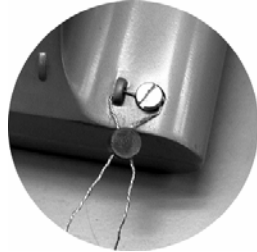

IND226:

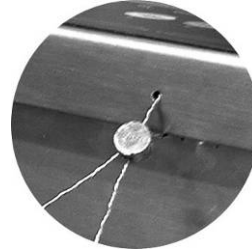

## 2.4 Battery Pack Option

### 2.4.1 Battery install

Recharge PCB install:

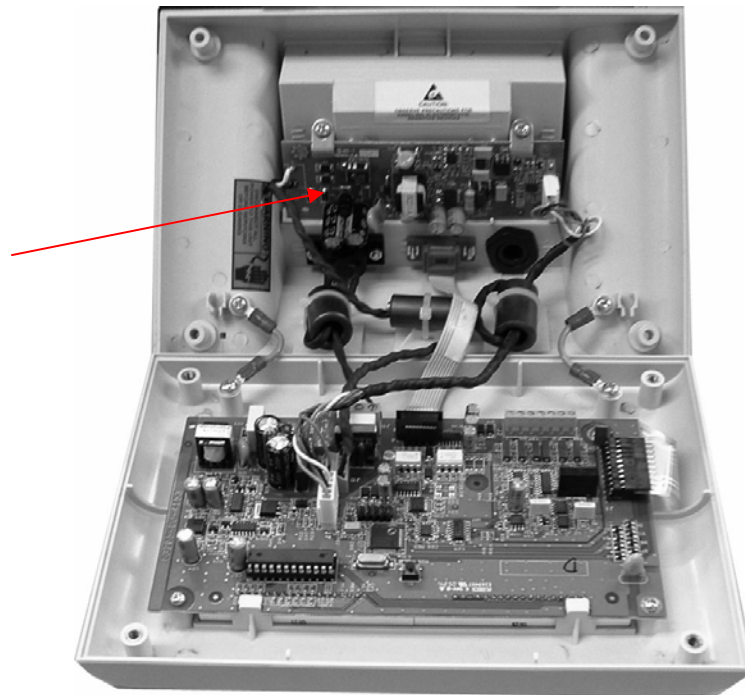

NI-HM battery pack install:

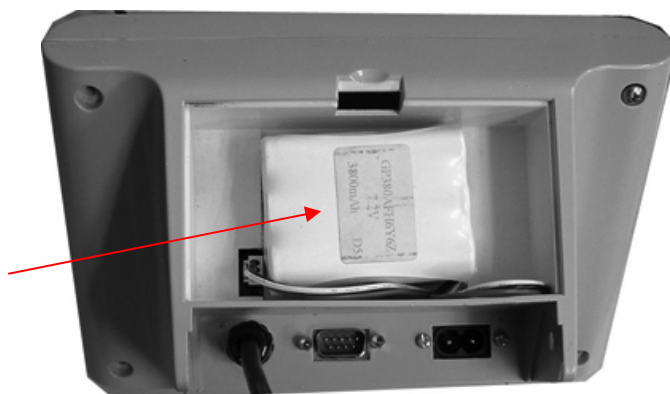

## 2.4.2 Recharge Battery

When the low battery cursor light on red color, it means the battery voltage is low, you can still continuous your work for about one hour..

When the low battery cursor flash on red color, it means the battery voltage is too low, you should charge the battery immediately.

Plug the AC power line will automatic recharge the battery, and the low battery cursor will light on green color. Normally the charge time is about 12 hours.

For new terminal, please charge the battery for 12 hours before use the battery.

## 2.4.3 Use Battery

Full charged battery can continuous work 35 hours.

The following setup can longer the work hour.:

- Set timeout (F3.1.1), When the scale hasn't operate for certain time, the terminal will automatic turn off the display. Only kg cursor light. And when the scale add weight or press any key. The terminal will automatically turn on the display.
- Set brightness to low (F3.1.2). When the terminal use battery, the display brightness will turn to low, when use AC power, the display brightness will automatically change to high.
- Set Auto power off(F3.2), When the scale haven't any operation in certain times, the terminal will automatically power off.

# 3.0 Operation

## 3.1 Operation HMI

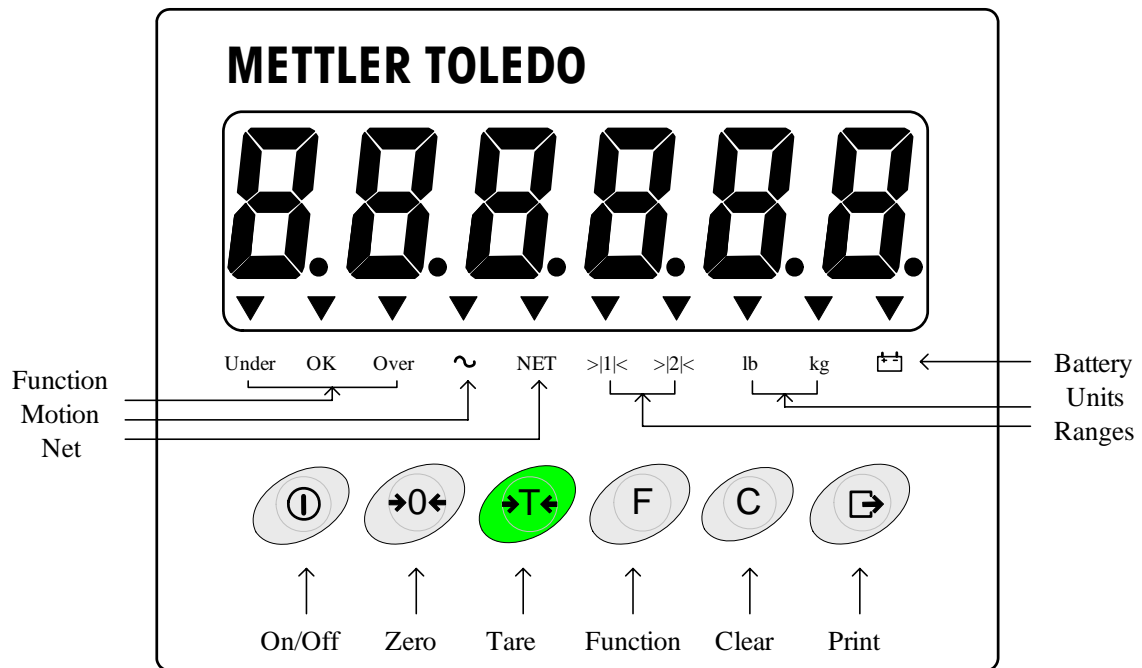

“Under OK Over” is use for check weighing. You can stick ”Count APW PCS” label for counting function.

## 3.2 Basic function operation

### 3.2.1 On/Off key

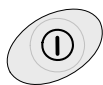

Hold the key 2 seconds, All display segments will light. The terminal will show software part number [178037] [L 1.00]. Then the terminal will show the normal weight.

In normal display state, Hold this key 2 seconds, the terminal will show [ - F F - ], then power off.

### 3.2.2 Zero



Zero the scale.

### 3.2.3 Tare

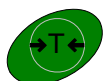

Tare the scale, the display will change to Net mode..

### 3.2.4 Clear



Clear the tare, the display will go back to gross mode.

### 3.2.5 Print



Print the current weight.

## 3.3 Expand functions

### 3.3.1 X10 Function

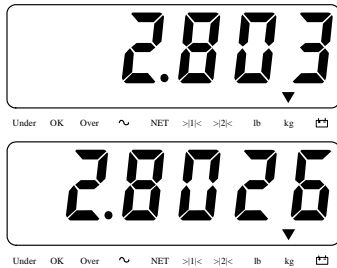

F2.1 is set to *10* - x10 function.

Press  key, The terminal will show more accuracy weight for 20 seconds.

Print is forbidden in this mode.

### 3.3.2 Unit switch

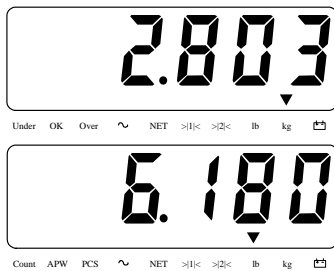

F2.1 is set to *Unit* - Unit switch

Press  key, you can switch the weight units at kg or lb.

### 3.3.3 Over/Under Function

F2.1 is set to *Over* - Over/Under function

● F2.1.1 is set to *Check* - Check weighing mode.

Target weight setting:

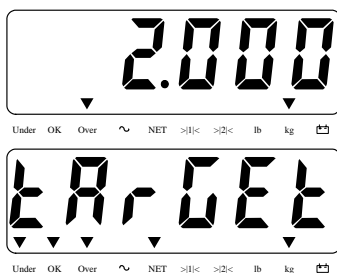

Press  key to switch Over/Under mode.

Hold  key for 2 seconds. Or you can press Tare key to tare the weight.



The terminal show the old target weight..

If *F2.2.2* is set to *THE IGH* - Get target weight from weighing. Then you can put the target

weight in scale platform. Press  key to set new target weight.

If *F2.2.2* is set to *MANUAL* - Manually set the target weight. You can input target weight directly, then press Enter to confirm.

Operation:



Current weight less than target weight and over tolerance.



Current weight near the target weight and within tolerance.



Current weight larger than target weight and over tolerance.

- *F2.1.1* is set to *CLASS* - Classifying mode.

Target weight setting:



Press  key to switch Over/Under mode.



Hold  key for 2 seconds. Or you can press Tare key to tare the weight.



The terminal show the old target weight..

If *F2.2.2* is set to *THE IGH* - Get target weight from weighing. Then you can put the target

weight in scale platform. Press  key to set new target weight.

If *F2.2.2* is set to *MANUAL* - Manually set the target weight. You can input target weight



Operation:

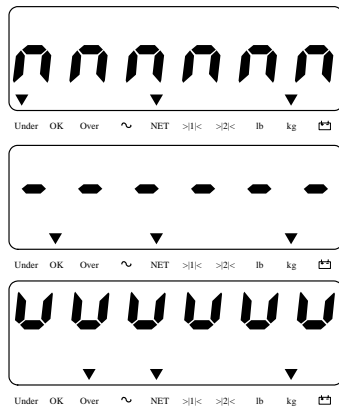

directly, then press Enter to confirm.

Current weight less than target weight and over tolerance.

Current weight near the target weight and within tolerance.

Current weight larger than target weight and over tolerance.

### 3.3.4 Counting Function

F2.1 is set to [count] - Counting function.

Stick "Count APW PCS" label at "Under OK Over" position.

Display Mode switch:

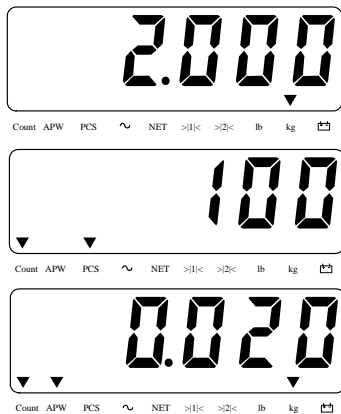



Normal display mode.

Press  key to switch counting PCS mode, show current pieces.

Press  key to switch counting APW mode, show average piece weight.

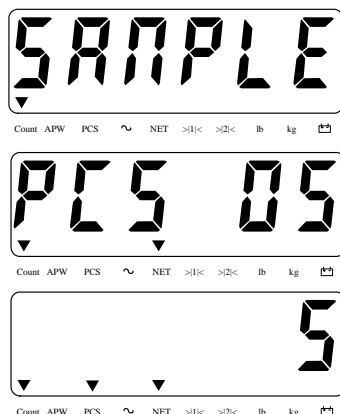
Sampling:



Hold  key 2 seconds. Or you can press Tare key to tare the weight.

Press  key to select sample pieces: 5,10,20,50. Put the sample pieces on scale platform, press Enter to confirm.

Display mode will go back to counting PCS mode.





APW Enhancement:



If  $F2.3 = 0n$ , Enable APW enhancement function. Then after the pieces number increased, the terminal will automatically adjust the average weight to get more accuracy pieces number.

## 4.0 Setup

### 4.1 Enter Setup

Hold  key 2 seconds, terminal will show [P R S E T E r] . Ask for password:

Supervisor password:     (Can setup every parameters).

Operator password:    (Can only setup F2).

Press  to confirm. Terminal will show [S E T U P] ..

If F1.1 is set OI ML or NTEP. Then F1, F5.1 and F5.4 will be disabled for setup. The only way you can setup them is turn off the terminal, hold the S1 key in PCB, then turn on the terminal. The terminal will show “S E T U P” directly, now you can setup everything.

### 4.2 Keys in setup

 Previous parameter.

 Next parameter.

 Confirm.



 Go back to previous setup

 Go back up level.



Digits Input: Press  key to edit current number. Change input cursor to left.

Press  key to clear current number.

Press  key to decrease. Press  key to increase.

Press  to confirm..

## 4.3 Setup Detail

### F 1 – Scale

#### F 1.1 – Approval

Selection:      **no** (Factory default) - none  
                   **0 1P7L**                    - OIML  
                   **n t E P**                    - NTEP  
                   **o t H E r**                    - Other approval

#### F 1.2 – Scale Capacity & Increments

##### F 1.2.1 – Units

Selection:      **1** - kg (Factory default)  
                   **2** - lb

##### F 1.2.2 – Ranges

Selection:      **1 r** – 1 Range (Factory default)  
                   **2 r** - 2 Ranges

##### F 1.2.3 – Capacity (First Range)

Selection:      **3** ... **20'000** (Factory default **5**)

##### F 1.2.4 – Increments (First Range)

Selection:      **0.000 1** ~ **10** (Factory default **0.00 1**)

##### F 1.2.5 – Capacity (Second Range)

Selection:      **3** ... **20'000** (Factory default **3**)

Notes: Capacity (Second Range) should less than Increments (First Range).

##### F 1.2.6 – Increments (Second Range)

Selection:      **0.000 1** ~ **10** (Factory default **0.00 1**)

### F 1.3 – Calibration

#### F 1.3.1 GEO Adjustment

Selection: 0...3 1 (Factory default 16)

#### F 1.3.2 – Linearity

Selection: 0n - Enabled  
OFFF - Disabled (Factory default)

#### F 1.3.3 – Calibration

- If F 1.3.2 is set to 0n

[E SCL] Empty scale.

Remove any load from scale platform, then press Enter to confirm. Terminal will count down from [ 10 [RL] ] to [ 0 [RL] ].

[FULL Ld] Add full load.

Add load on the scale platform, then press Enter.

[000000] Input weight number, then press Enter to confirm. Terminal will count down from [ 10 [RL] ] to [ 0 [RL] ].

[ donE ] Complete.

- If F 1.3.2 is set to OFFF

[E SCL] Empty scale.

Remove any load from scale platform, then press Enter to confirm. Terminal will count down from [ 10 [RL] ] to [ 0 [RL] ].

[Add Ld] Add middle load

Add load on the scale platform, then press Enter.

[000000] Input weight number, then press Enter to confirm. Terminal will count down from [ 10 [RL] ] to [ 0 [RL] ].

[FULL Ld] Add full load.

Add load on the scale platform, then press Enter.

[000000] Input weight number, then press Enter to confirm. Terminal will count down from [ 10 [RL] ] to [ 0 [RL] ].

[ donE ] Complete.

### F 1.4 – Zero Function

#### F 1.4.1 – AZM

Selection: OFF, 0.5d (Factory default), 1d, 3d

#### F 1.4.2 – Power up Zero

Selection: OFF, 2%, 10% (Factory default), 20%

#### F 1.4.3 – Pushbutton Zero

Selection: OFF, 2% (Factory default), 10%, 20%

If F1.1 is set to OIML, Then F1.4.2 will set to 10%, and F1.4.3 will set to 2%.

### F 1.5 – Tare Function

**F 1.5.1 – Auto Tare**

Selection: **0n,0FF** (Factory default)

**F 1.5.2 – Auto Clear**

Selection: **0n,0FF** (Factory default)

**F 1.5.3 – Tare Interlock**

Selection: **0n,0FF** (Factory default)

**F 1.5.4 – Auto Tare threshold.**

Selection: **0 ~ FS** (Factory default **10d**)

**F 1.5.5 – Auto Tare reset threshold**

Selection: **0 ~ FS** (Factory default **10d**)

**F 1.5 – Digital filter**

**F 1.5.1 – Digital filter**

Selection: **L0** - Low  
**07Ed** (Factory default) - Middle  
**H1GH** - High

**F 1.5.2 – Motion range**

Selection: **0.5d** (Factory default), **1d,3d**

**F 1.10 – F 1 Factory default**

Reset all F 1 parameters to Factory default. Not include calibration values.

**F2 – Application**

**F2.1 – F key function**

Selection: **07UL 10** (Factory default) - x10  
**Un t** - Unit switch  
**0UEr** - Over/Under  
**Count** - Counting

**F2.2 – Over/Under function**

**F2.2.1 – Display mode**

Selection: **CHECh** (Factory default) - Check weighing  
**CLASS** - Classifying

**F2.2.2 – Target Input**

Selection: **HE 1GHt** (Factory default) - By weight  
**MANUAL** - Manually

**F2.2.3 – Plus Tolerance**

Selection: 0...F5 (Factory default 10d)

#### F2.2.4 – Minus Tolerance

Selection: 0...F5 (Factory default 10d)

#### F2.3 – APW Enhancement (F2.1 is set to Counting)

Selection: 0n,OFF (Factory default)

F2.10 – F2 reset to Factory default

All F2 parameters will be set to Factory default.

### F3 – Terminal

#### F3.1 – Display

##### F3.1.1 – Timeout

Selection: 0, 10~999 seconds (Factory default 60s) 0 will disabled this function.

##### F3.1.2 – Brightness

Selection: Lo (Factory default) - Low bright  
Hi 10H - High bright

Recommend to set Low if you use battery to operation.

#### F3.2 – Auto power off

Selection: 0, 5~60 minutes (Factory default 5 minutes) 0 will disabled this function.

#### F3.3 – Battery type

Selection: dry (Factory default) — Dry battery  
Ni-MH — Ni-MH rechargeable battery  
Lead-Ac — Lead-Acid rechargeable battery

F3.10 – F3 reset to Factory default

All F3 Parameters will be set to Factory default.

### F4 – Communication

#### F4.1 – Connections

Selection: Print (Factory default) - Demand print  
Auto Print - Auto print  
SICS - SICS  
Toledo cont - Toledo continuous mode

#### F4.2 – Format

##### F4.2.1 – Line format

Selection: Multi (Factory default) - Multi line  
Single - Single line

#### F 4.2.2 – Print format

Selection:     **STAND** (Factory default)- Standard  
                  **OVER**                             - Over/Under  
                  **COUNT**                            - Count

#### F 4.2.3 – Print languages

Selection:     **ENG** (Factory default)     - English  
                  **CHN**                             - Chinese

#### F 4.2.4 – Add Line Feed

Selection:     **0~9** (Factory default **3**)

#### F 4.2.5 – Auto print threshold

Selection:     **0 ~ FS** (Factory default **10**)

#### F 4.2.6 – Auto print reset threshold

Selection:     **0 ~ FS** (Factory default **10**)

#### F 4.3 – Com1

##### F 4.3.1 – Baud rate

Selection:     **1200, 2400, 4800, 9600** (Factory default), **19200**

##### F 4.3.2 – Data bits/Parity

Selection:     **7-odd**                             - 7 bits odd parity  
                  **7-EVEN**                        - 7 bits even parity  
                  **8-NONE** (Factory default)- 8 bits none parity

##### F 4.3.3 – Xon/Xoff

Selection:     **ON**                               - Enabled  
                  **OFF** (Factory default)     - Disabled

##### F 4.3.4 – Checksum

Selection:     **ON**                               - Enabled  
                  **OFF** (Factory default)     - Disabled

#### F 4.10 – F 4 reset to Factory default

All F 4 parameters will reset to Factory default.

### **F 5 – Maintenance**

#### F 5.1 – Calibration values

##### F 5.1.1 – Zero Counts

##### F 5.1.2 – Middle load weight (half capacity)

##### F 5.1.3 – Middle load counts

##### F 5.1.4 – Full load weight

**F5.1.5** – Full load Counts

**F5.2** – Keypad test

Terminal show "PrE55", You can press Zero, Tare, F, Clear, Print. On/Off key to exit..

**F5.3** – Display test

All display segments will light.

**F5.4** – Display internal resolution

Display internal resolution.

**F5.5** – COM1 test

Connect COM1 to computer to test COM1..

**F5.6** – Print setup

Print all setup parameters..

**F5.10** – Reset all parameters to Factory default

Reset all **F1~F4** Reset all parameters to Factory default. Not include calibration values.

## **F5 – Exit Setup**

[**SAVE**] Press Enter to confirm save changes and exit..

Press Tare key, the terminal will show[**Abort**], will not save changes and exit..

## 5.0 Terminal Maintenance

### 5.1 Daily maintenance

Main PCB:

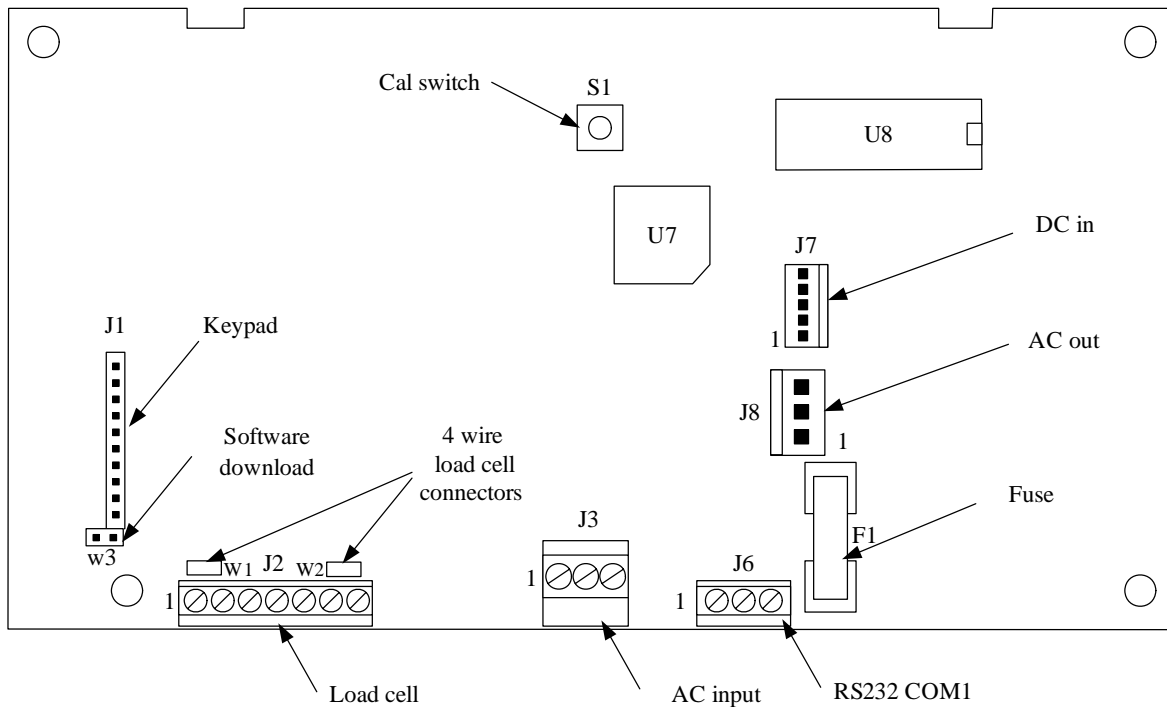

- J1 - Keypad connector.
- J2 - Load cell connector.
- J3 - RS232 connector.
- J6 - AC power in, 87~264VAC.
- J7 - DC power in, from rechargeable PCB and Dry battery.
- J8 - AC power out, to rechargeable PCB.
- W1 ,W2 - 4 wires load cell connectors.
- W3 - Software download.
- S1 - Calibration switch.
- F1 - Fuse , 250V 1.5A.

### 5.2 Error Messages

Message	Possible reasons	Solution
---------	------------------	----------

┌───┐	Over load, more than 9d above scale capacity	Reduce the load
└───┘	Under Zero 5d	Zero the scale
┌──no┐ └no┘	Over the zero range	Remove the load
--no--	Key forbidden	Check setup
Err 3	EEPROM verify error	Reset the terminal
Err 35	Scale is in motion when calibration	Check the scale
Err 4	Samples number too small.	Add sample number
Err 6	EEPROM W/R error	Replace EEPROM
Err 70	The keys hold too long The key may be short	Replace keypad
Terminal auto power off	Terminal is set auto power off. Battery voltage to low.	Press On/off key Recharge battery
Terminal not light after power on	Fuse break	Replace fuse

### 5.3 Software download

IND221 and IND226 can download software in the field.  
Protocol: 19200,8,None,Xmodem.